

Errata

Title & Document Type:

Manual Part Number:

Revision Date:

HP References in this Manual

This manual may contain references to HP or Hewlett-Packard. Please note that Hewlett-Packard's former test and measurement, semiconductor products and chemical analysis businesses are now part of Agilent Technologies. We have made no changes to this manual copy. The HP XXXX referred to in this document is now the Agilent XXXX. For example, model number HP8648A is now model number Agilent 8648A.

About this Manual

We've added this manual to the Agilent website in an effort to help you support your product. This manual provides the best information we could find. It may be incomplete or contain dated information, and the scan quality may not be ideal. If we find a better copy in the future, we will add it to the Agilent website.

Support for Your Product

Agilent no longer sells or supports this product. You will find any other available product information on the Agilent Test & Measurement website:

www.tm.agilent.com

Search for the model number of this product, and the resulting product page will guide you to any available information. Our service centers may be able to perform calibration if no repair parts are needed, but no other support from Agilent is available.



User and Service Guide

Publication number 54600-97021
November 1997 (pdf version Nov 1998)

For Safety Information, Warranties, and Regulatory information,
see the pages behind the index.

© Copyright Hewlett-Packard Company 1992, 1997
All Rights Reserved

HP 54600B, HP54601B, HP 54602B, and HP 54603B Oscilloscopes

General-Purpose Oscilloscopes

The HP 54600B-Series Oscilloscopes offer exceptional waveform viewing and measurements in a small, lightweight package. The two-channel HP 54600B and HP 54603B are suited for production, field service, and education applications. The four-channel HP 54601B is best suited for research and design labs, and applications involving digital circuit test and troubleshooting. For higher frequency applications, the HP 54602B provides 150 MHz bandwidth and triggering up to 250 MHz. Each of these oscilloscopes gives you:

- 60-MHz bandwidth (HP 54603B)
100-MHz bandwidth (HP 54600B and HP 54601B)
150-MHz bandwidth (HP 54602B)
- Automatic setup of the front panel
- Automatic and cursor measurements of frequency, time, and voltage
- Waveform storage
- Save and recall of 16 front-panel setups
- Peak detect

These oscilloscopes are easy to use with familiar controls and high display update rate, but with none of the viewing problems that are associated with analog oscilloscopes. A bright, crisp display is obtained at all sweep speeds and delayed sweep magnifications. Storage is as simple as pressing a button. Negative time allows the viewing of events that occur before the trigger event. Cursors and automatic measurements greatly simplify the analysis of these events.

You can upgrade this oscilloscope for hardcopy or remote control with the addition of an interface module. Unattended waveform monitoring and additional waveform math, such as FFT, can be added with the addition of one of the Measurement/Storage modules.

Bring your scope and PC together with BenchLink software. BenchLink, which runs under Windows, allows easy transfer of scope traces and waveform data to your PC for incorporation into documents or storage.

Accessories supplied

- Two 1.5 meter, 10:1 Probes (HP 10071A)
- Power cord for country of destination
- This *User and Service Guide*
- *Programmer's Guide* with Microsoft Windows Help file, ascii help file, and sample programs.

Accessories available

- HP 34810B BenchLink/Scope Software for Windows
- HP 54650A HP-IB Interface Module
- HP 54652A Parallel Interface Module
- HP 54654A Operator's Training Kit
- HP 54655A and HP 54656A Test Automation Modules
- HP 54657A HP-IB Measurement Storage Module
- HP 54659B Serial/Parallel Measurement/Storage Modules
- HP 5041-9409 Carrying Case
- HP 5062-7345 Rackmount Kit
- HP 10070A 1.5 meter, 1:1 Probe
- HP 10100C 50 Ω Termination

Options available

- Option 001 RS-03 Magnetic Interference Shielding Added to CRT
- Option 002 RE-02 Display Shield Added to CRT
- Option 005 Enhanced TV/Video Trigger (HP 54602B only)
- Option 090 Deletes Probes
- Option 101 Accessory Pouch and Front-Panel Cover
- Option 102 Two Additional HP 10071A 10:1 Probes (HP 54602B only)
- Option 103 Operator's Training Kit (HP 54654A)
- Option 104 Carrying Case (HP 5041-9409)
- Option 106 BenchLink/Scope Software (HP 34810B)
- Option 1CM Rackmount Kit (HP 5062-7345)
- Power Cords (see the table of Replaceable Parts at the end of Chapter 4, Service.)

In This Book

This manual is the user and service guide for the HP 54600B, HP 54601B, HP 54602B, and HP 54603B Oscilloscopes, and contains five chapters.

First Time Users Chapter 1 is a quick start guide that gives you a brief overview of the oscilloscope.

Advanced users Chapter 2 is a series of exercises that guide you through the operation of the oscilloscope.

TV/Video triggering Chapter 3 shows how to use enhanced TV/Video triggering if you have Option 005 installed in your oscilloscope.

Service technicians Chapter 4 contains the service information for the oscilloscope. There are procedures for verifying performance, adjusting, troubleshooting, and replacing assemblies in the oscilloscope.

Reference information Chapter 5 lists the characteristics of the oscilloscope.

1	The Oscilloscope at a Glance
2	Operating Your Oscilloscope
3	Using Option 005 Enhanced TV/Video Trigger (HP 54602B)
4	Service
5	Performance Characteristics
	Glossary
	Index

Contents

1 The Oscilloscope at a Glance

- To inspect the instrument 1-6
- To clean the instrument 1-6
- To connect a signal to the oscilloscope 1-7
- To display a signal automatically 1-9
- To set up the vertical window 1-10
- To set up the time base 1-12
- To trigger the oscilloscope 1-14
- To use roll mode 1-16

2 Operating Your Oscilloscope

- To use delayed sweep 2-3
- To use storage oscilloscope operation 2-6
- To capture a single event 2-8
- To capture glitches or narrow pulses 2-10
- To trigger on a complex waveform 2-12
- To make frequency measurements automatically 2-14
- To make time measurements automatically 2-16
- To make voltage measurements automatically 2-19
- To make cursor measurements 2-22
- To view asynchronous noise on a signal 2-26
- To reduce the random noise on a signal 2-28
- To save or recall traces 2-31
- To save or recall front-panel setups 2-32
- To reset the instrument setup 2-33
- To use the XY display mode 2-34
- To analyze video waveforms 2-38

Contents

3 Using Option 005 Enhanced TV/Video Trigger (HP 54602B)

- To select TV display grid 3-4
- To autoscale on a video signal 3-4
- To trigger on a specific line of video 3-5
- To trigger on all TV line sync pulses 3-7
- To trigger on a specific field of the video signal 3-8
- To trigger on all fields of the video signal 3-9
- To trigger on odd or even fields 3-10
- To make cursor measurements 3-12
- To use delayed sweep 3-14
- To analyze video waveforms with Option 005 3-16
- To window in on harmonic distortion using FFT 3-18
- To connect to other instruments 3-20

4 Service



- To return the oscilloscope to Hewlett-Packard 4-4

- Verifying Oscilloscope Performance 4-5
 - To check the output of the DC CALIBRATOR 4-6
 - To verify voltage measurement accuracy 4-7
 - To verify bandwidth 4-10
 - To verify bandwidth (alternate method) 4-12
 - To verify horizontal Δt and $1/\Delta t$ accuracy 4-16
 - To verify trigger sensitivity 4-18
 - To verify Vertical Output on Option 005 4-22

Adjusting the Oscilloscope	4-27
To adjust the power supply	4-28
To perform the self-calibration	4-31
To adjust the low-frequency compensation	4-33
To adjust the high-frequency pulse response	4-35
To adjust the display	4-37
To adjust the Option 005 offset (R15) (HP 54602B only)	4-39
Troubleshooting the Oscilloscope	4-40
To construct your own dummy load	4-41
To check out the oscilloscope	4-42
To check the Low Voltage Power Supply	4-45
To run the internal self-tests	4-46
To troubleshoot Option 005 (HP 54602B only)	4-48
Replacing Parts in the Oscilloscope	4-49
To replace an assembly	4-50
To remove the fan	4-51
To remove the front panel	4-51
To remove the display	4-53
To remove the system board	4-53
Power supply	4-54
Keyboard	4-55
To remove the handle	4-56
To remove the Option 005 board	4-56
To order a replacement part	4-57

Contents

5 Performance Characteristics

	Vertical System	5-3
	Horizontal System	5-5
	Trigger System	5-6
	XY Operation	5-8
	Display System	5-8
	Acquisition System	5-9
	Advanced Functions	5-10
	Power Requirements	5-10
	General	5-11
	Option 005 General Performance Characteristics (HP 54602B only)	5-13
	Option 005 Trigger System (HP 54602B only)	5-14

Glossary

Index

The Oscilloscope at a Glance

The Oscilloscope at a Glance

One of the first things you will want to do with your new oscilloscope is to become acquainted with its front panel. Therefore, we have written the exercises in this chapter to familiarize you with some of its controls.

The front panel has knobs, grey keys, and white keys. The knobs are used most often and are similar to the knobs on other oscilloscopes. The grey keys bring up softkey menus on the display that allow you access to many of the oscilloscope features. The white keys are instant action keys and menus are not associated with them.

Throughout this book, the front-panel keys are denoted by a box around the name of the key, and softkeys are denoted by a change in the text type. For example, **Source** is the grey front-panel key labeled source under the trigger portion of the front panel, and **Line** is a softkey. The word **Line** is at the bottom of the display directly above an unlabeled softkey (which is also grey).

Figure 1-1 is a diagram of the front-panel controls and input connectors of the HP 54600B and HP 54603B. Figure 1-2 is a diagram of the front-panel controls and input connectors of the HP 54601B and HP 54602B.

Figure 1-3 is a status line example on the HP 54602B. The status line, located at the top of of the display, lets you quickly determine the setup of the oscilloscope. In this chapter you will learn to read at a glance the setup of the oscilloscope from the status line.

Figure 1-4 is a diagram showing which grey keys to press to bring up the various softkey menus.

Figure 1-1

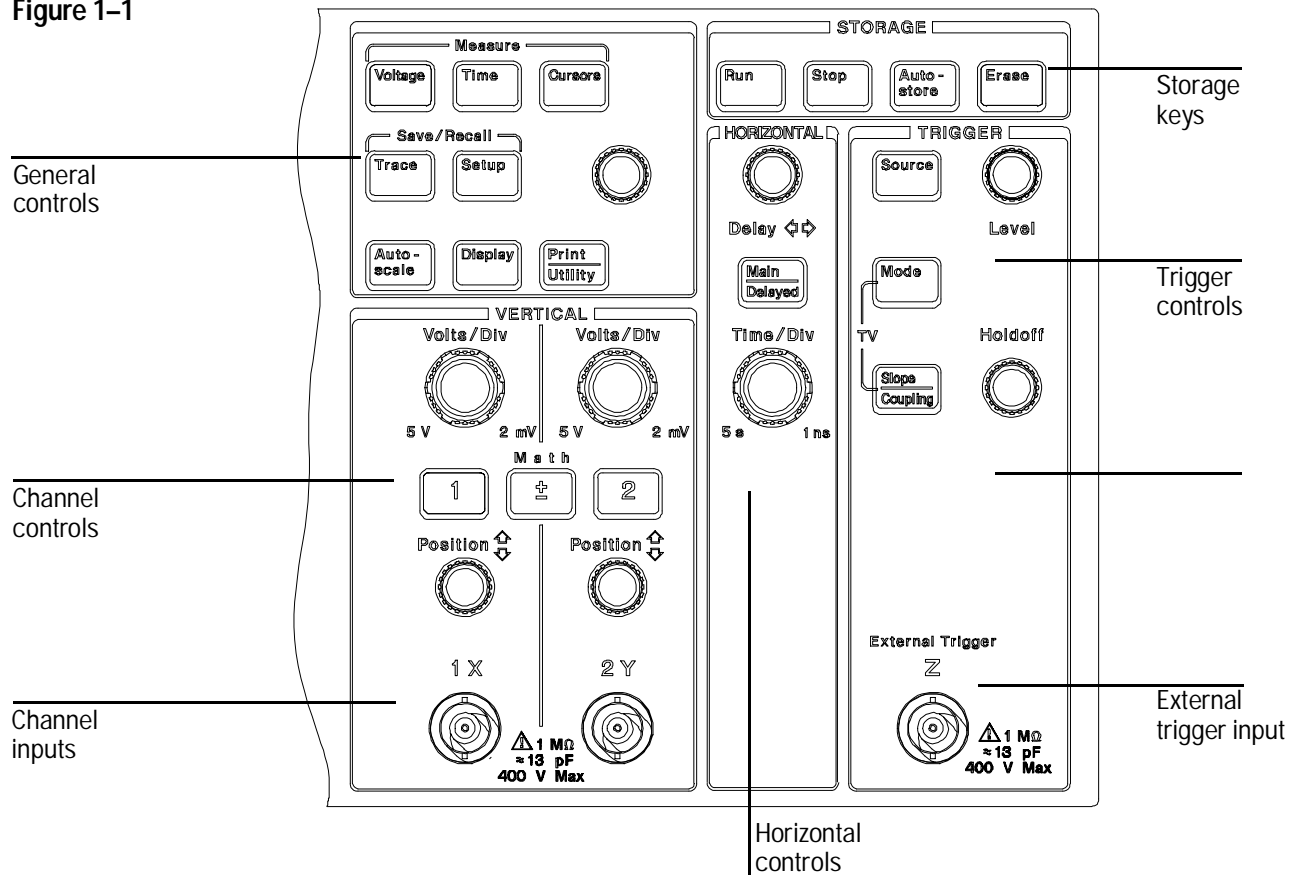

HP 54600B and HP 54603B Front Panel Controls

Figure 1-4

Press this key

To obtain this menu

↓

1
OR
2

3
OR
4

$\frac{+}{-}$

Main
Delayed

Roll mode
Main
Delayed

Source

Mode

Slope
Coupling

TV MODE
Slope
Coupling

Print
Utility

54600E18

54600E19

54600E08

54600E20

54600E72

54600E10

54600E09

54600E15

54600E21

54600E24
54600E75

1 Coupling BW Lim Invert Vernier Probe
Off On DC AC Off On Off On Off On 10 100

3 Coupling V/Div Probe
Off On DC $\frac{+}{-}$.1V .5V 10 100

Channel Math
Off 1+2 1-2

Horizontal Mode Vernier Time Ref
Main Delayed XY Roll Off On Lft **Enter**

Horizontal Mode Vernier Time Ref
Main Delayed XY Roll Off On **Enter** right

Trigger Source
1 2 3 4 Line

Trigger Mode
Auto Lvl Auto Normal Single TV

Slope Reject Noise Rej
 $\frac{+}{-}$ DC AC Off LF HF off On

TV Mode HF Rej
Field 1 Field 2 Line Off On

Print Screen Clear Self Tst Self Cal
Menu Menu Menu

Press this key

To obtain this menu

↓

Cursors

Display

Setup

Trace

Voltage

Next
Menu

Time

Next
Menu

54600E16

54600E11

54600E12

54600E17

54600E14

54600E23

54600E13

54600E22
54600E74

Source Active Cursor Clear
1 234 V 1 V 2 t 1 t 2 Cursors

Display Mode # Average Vectors Grid
Normal Peak Det Average 64 256 Off On Off On

Setup Memory Undo Default
1 Save Recall Autoscale Setup

Trace Trace Mem1 Save to Clear Recall
Mem1 Mem2 Off On Mem1 Mem1 Setup

Source Voltage Measurements Clear Next
1 234 V p-p V avg V rms Meas Menu

Show Meas Voltage Measurements Previous
Off On Vmax Vmin Vtop Vbase Menu

Source Time Measurements Clear Next
1 234 Freq Period Duty Cy Meas Menu

Show Meas Time Measurements Previous
Off On +Width -Width RiseTime FallTime Menu

Softkey Menu Reference

To inspect the instrument

- Inspect the shipping container for damage.

Keep a damaged shipping container or cushioning material until the contents of the shipment have been checked for completeness and the instrument has been checked mechanically and electrically.

- Check the accessories.

Accessories supplied with the instrument are listed in "Accessories Supplied" in the front of this manual.

- If the contents are incomplete or damaged notify your HP sales office.

- Inspect the instrument.

- If there is mechanical damage or defect, or if the instrument does not operate properly or pass performance tests, notify your HP sales office.
 - If the shipping container is damaged, or the cushioning materials show signs of stress, notify the carrier as well as your HP sales office. Keep the shipping materials for the carrier's inspection. The HP office will arrange for repair or replacement at Hewlett-Packard's option without waiting for claim settlement.
-

To clean the instrument

If this instrument requires cleaning, disconnect it from all power sources and clean it with a mild detergent and water. Make sure the instrument is completely dry before reconnecting it to a power source.

To connect a signal to the oscilloscope

The HP 54600B and HP 54603B are a two-channel oscilloscopes with an external trigger input, while the HP 54601B and HP 54602B are four-channel oscilloscopes. The four-channel oscilloscope replaces the external trigger input with channels 3 and 4. In this exercise you connect a signal to the channel 1 input.

To avoid damage to your new oscilloscope, make sure that the voltage level of the signal you are using is less than or equal to 400 V (dc plus the peak ac). For a complete list of the characteristics see chapter 5, "Performance Characteristics."

- **Use a cable or a probe to connect a signal to channel 1.**

If you are using a probe, the oscilloscope allows you to enter the attenuation factor for the probe. The attenuation factor changes the vertical scaling of the oscilloscope so that the measurement results reflect the actual voltage levels at the probe tip.

- **To set the probe attenuation factor press . Next toggle the **Probe** softkey to change the attenuation factor to match the probe you are using.**

The Oscilloscope at a Glance

To connect a signal to the oscilloscope

You should compensate 10:1 probes to match their characteristics to the oscilloscope. A poorly compensated probe can introduce measurement errors. To compensate a probe, follow these steps.

- 1 Connect the 10:1 probe from channel 1 to the front-panel probe adjust signal on the oscilloscope.
- 2 Press **Autoscale** .
- 3 Use a nonmetallic tool to adjust the trimmer capacitor on the probe for the flattest pulse possible as displayed on the oscilloscope.

Figure 1-5

Overcompensation causes pulse peaking.

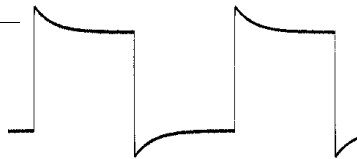

Figure 1-6

Correct compensation with a flat pulse top.

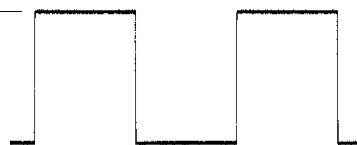
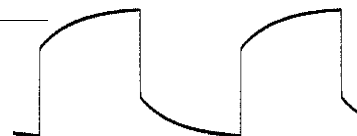

Figure 1-7

Undercompensation causes pulse rolloff.



To display a signal automatically

The oscilloscope has an Autoscale feature that automatically sets up the oscilloscope to best display the input signal. Using Autoscale requires signals with a frequency greater than or equal to 50 Hz and a duty cycle greater than 1%.

When you press the Autoscale key, the oscilloscope turns on and scales all channels that have signals applied, and it selects a time base range based on the trigger source. The trigger source selected is the highest numbered input that has a signal applied. (If a signal is connected to the external trigger input on the HP 54600B and HP 54603B, then it is selected as the trigger source.)

- 1 Connect a signal to the oscilloscope.
- 2 Press **Autoscale** .

When you press the Autoscale key, the oscilloscope changes the front-panel setup to display the signal. However, if you pressed the Autoscale key unintentionally, you can use the Undo Autoscale feature. To use this feature, perform the following step.

- Press **Setup** . Next, press the **Undo Autoscale** softkey.

The oscilloscope returns to the configuration in effect before you pressed the Autoscale key.

To set up the vertical window

The following exercise guides you through the vertical keys, knobs, and status line.

1 Center the signal on the display with the Position knob.

The Position knob moves the signal vertically, and it is calibrated. Notice that as you turn the Position knob, a voltage value is displayed for a short time indicating how far the ground reference is located from the center of the screen. Also notice that the ground symbol on the right side of the display moves in conjunction with the Position knob.

Measurement hints

If the channel is dc coupled, you can quickly measure the dc component of the signal by simply noting its distance from the ground symbol.

If the channel is ac coupled, the dc component of the signal is removed allowing you to use greater sensitivity to display the ac component of the signal.

2 Change the vertical setup and notice that each change affects the status line differently.

You can quickly determine the vertical setup from the status line in the display.

- Change the vertical sensitivity with the Volts/Div knob and notice that it causes the status line to change. For channels 3 and 4 on the HP 54601B and HP 54602B, press **3** or **4**. Then use the softkeys to change the vertical sensitivity.

- Press **1**.

A softkey menu appears on the display, and the channel turns on (or remains on if it was already turned on).

- Toggle each of the softkeys and notice which keys cause the status line to change.

Channels 1 and 2 have a vernier softkey that allows the Volt/Div knob to change the vertical step size in smaller increments. These smaller increments are calibrated, which results in accurate measurements even with the vernier turned on.

- To turn the channel off, either press **1** a second time or press the left-most softkey.

Invert operating hint

When you are triggered on the signal you are inverting, the inversion also applies to the trigger signal (what was a rising edge now is a falling edge). If the signal has a 50% duty cycle (square wave or sine wave), the displayed waveform appears not to invert. However, for signals with a duty cycle other than 50%, the displayed waveform does invert as you would expect.

To set up the time base

The following exercise guides you through the time base keys, knobs, and status line.

- 1 Turn the Time/Div knob and notice the change it makes to the status line.**

The Time/Div knob changes the sweep speed from 2 ns to 5 s in a 1-2-5 step sequence, and the value is displayed in the status line.

- 2 Change the horizontal setup and notice that each change affects the status line differently.**

- Press **Main/Delayed** .

A softkey menu appears on the display with six softkey choices.

- Toggle each of the softkeys and notice which keys cause the status line to change.

There is also a horizontal vernier softkey that allows the Time/Div knob to change the sweep speed in smaller increments. These smaller increments are calibrated, which results in accurate measurements even with the vernier turned on.

- Turn the Delay knob and notice that its value is displayed in the status line.

The Delay knob moves the main sweep horizontally, and it pauses at 0.00 s, mimicking a mechanical detent. At the top of the graticule is a solid triangle (▼) symbol and an open triangle (∇) symbol. The ▼ symbol indicates the trigger point and it moves in conjunction with the Delay knob. The ∇ symbol indicates the time reference point. If the time reference softkey is set to left, the ∇ is located one graticule in from the left side of the display. If the time reference softkey is set to center, the ∇ is located at the center of the display. The delay number tells you how far the reference point ∇ is located from the trigger point ▼.

All events displayed left of the trigger point ▼ happened before the trigger occurred, and these events are called pretrigger information. You will find this feature very useful because you can now see the events that led up to the trigger point. Everything to the right of the trigger point ▼ is called posttrigger information. The amount of delay range (pretrigger and posttrigger information) available is dependent on the sweep speed selected. See "Horizontal System" in chapter 5 for more details.

To trigger the oscilloscope

The following exercise guides you through the trigger keys, knobs, and status line.

1 Turn the trigger Level knob and notice the changes it makes to the display.

On the HP 54601B and HP 54602B and on an internally triggered HP 54600B and HP 54603B, as you turn the Level knob or press a trigger menu key, for a short time two things happen on the display. First, the trigger level is displayed in inverse video. If the trigger is dc coupled, it is displayed as a voltage. If the trigger is ac coupled or if LF reject was selected, it is displayed as a percentage of the trigger range. Second, if the trigger source is turned on, a line is displayed showing the location of the trigger level (as long as ac coupling or low frequency reject are not selected).

2 Change the trigger setup and notice that each change affects the status line differently.

- Press **Source**.

A softkey menu appears on the display showing the trigger source choices.

- Toggle each of the softkeys and notice that each key causes the status line to change.
- Press **Mode**.

A softkey menu appears on the display with five trigger mode choices.

- Toggle the **Single** and **TV** softkeys and notice that they affect the status line differently. (You can only select TV if the trigger source is either channel 1 or 2.)

When the oscilloscope is triggering properly, the trigger mode portion of the status line is blank.

What happens if the oscilloscope loses trigger?

If Auto Level is the trigger mode, Auto flashes in the status line. If dc coupled, the oscilloscope resets the trigger level to the center of the signal. If ac coupled, the oscilloscope resets the trigger level to the middle of the screen. (Every time you press the Auto Level softkey, the oscilloscope resets the trigger level.)

If Auto is the trigger mode, Auto flashes in the status line and the oscilloscope free runs.

If either Normal or TV is the trigger mode, the trigger setup flashes in the status line.

- Press **Slope/Coupling** .

A softkey menu appears on the display. If you selected Auto level, Auto, Normal, or Single as a trigger mode, six softkey choices are displayed. If you selected TV as a trigger source, five other softkey choices are available.

- Toggle each of the softkeys and notice which keys affect the status line. On the HP 54600B and HP 54603B, external trigger is always dc coupled. If you select ac coupling or low frequency reject, these functions do not occur until you change the trigger source to channel 1, channel 2, or line.

3 Adjust the Holdoff knob and notice the change it makes to the display.

Holdoff keeps the trigger from rearming for an amount of time that you set with the Holdoff knob. Holdoff is often used to stabilize the complex waveforms. The Holdoff range is from 200.0 ns to about 13.5 s. It is displayed, for a short time, in inverse video near the bottom of the display.

To use roll mode

Roll mode continuously moves data across the display from right to left. It allows you to see dynamic changes (like adjusting a potentiometer) on low frequency signals. Two frequently used applications are transducer monitoring and power supply testing.

- 1 Press **Mode** . Then press the **Auto Lvl**, **Auto**, or **Normal** softkey.
- 2 Press **Main/Delayed** .
- 3 Press the **Roll** softkey.

The oscilloscope is now untriggered and runs continuously. Also notice that the time reference softkey selection changes to center and right.

- 4 Press **Mode** . Then press the **Single** softkey.

The oscilloscope fills either $\frac{1}{2}$ or $\frac{9}{10}$ of the display (depending on the time reference selection), then it searches for a trigger. After a trigger is found, the remainder of the display is filled. Then, the oscilloscope stops acquiring data.

You can also make automatic measurements in the roll mode. Notice that the oscilloscope briefly interrupts the moving data while it makes the measurement. The acquisition system does not miss any data during the measurement. The slight shift in the display after the measurement is complete is that of the display catching up to the acquisition system.

Roll mode operating hints

- Roll mode operates on channels 1 and 2 only.
- Math functions, averaging, and peak detect are not available.
- Holdoff and horizontal delay do not affect the signal.
- Both a free running (nontriggered) display and a triggered display (available in the single mode only) are available.
- Roll mode is available at sweep speeds up to 200 ms.

Operating Your Oscilloscope

Operating Your Oscilloscope

By now you are familiar with the VERTICAL, HORIZONTAL, and TRIGGER groups of the front-panel keys. You should also know how to determine the setup of the oscilloscope by looking at the status line. If you are unfamiliar with this information, we recommend you read chapter 1, "The Oscilloscope at a Glance."

This chapter takes you through two new groups of front-panel keys: STORAGE, and the group of keys that contains the Measure, Save/Recall, and Display keys. You will also add to your knowledge of the HORIZONTAL keys by using delayed sweep.

We recommend you perform all of the following exercises so you become familiar with the powerful measurement capabilities of the oscilloscope.

To use delayed sweep

Delayed sweep is a magnified portion of the main sweep. You can use delayed sweep to locate and horizontally expand part of the main sweep for a more detailed (high resolution) analysis of signals. The following steps show you how to use delayed sweep. Notice that the steps are very similar to operating the delayed sweep in analog oscilloscopes.

- 1** Connect a signal to the oscilloscope and obtain a stable display.
- 2** Press **Main/Delayed**.
- 3** Press the **Delayed** softkey.

The screen divides in half. The top half displays the main sweep, and the bottom half displays an expanded portion of the main sweep. This expanded portion of the main sweep is called the delayed sweep. The top half also has two solid vertical lines called markers. These markers show what portion of the main sweep is expanded in the lower half. The size and position of the delayed sweep are controlled by the Time/Div and Delay knobs. The Time/Div next to the  symbol is the delayed sweep sec/div. The delay value is displayed for a short time at the bottom of the display.

- To display the delay value of the delayed time base, either press **Main/Delayed** or turn the Delay knob.
- To change the main sweep Time/Div, you must turn off the delayed sweep.

Operating Your Oscilloscope

To use delayed sweep

Since both the main and delayed sweeps are displayed, there are half as many vertical divisions so the vertical scaling is doubled. Notice the changes in the status line.

- To display the delay time of the delayed sweep, either press **Main/Delayed** or turn the delay knob. The delay value is displayed near the bottom of the display.

4 Set the time reference to either left or center.

Figure 2-1 shows the time reference set to left. The operation is like the delayed sweep of an analog oscilloscope, where the delay time defines the start of the delayed sweep.

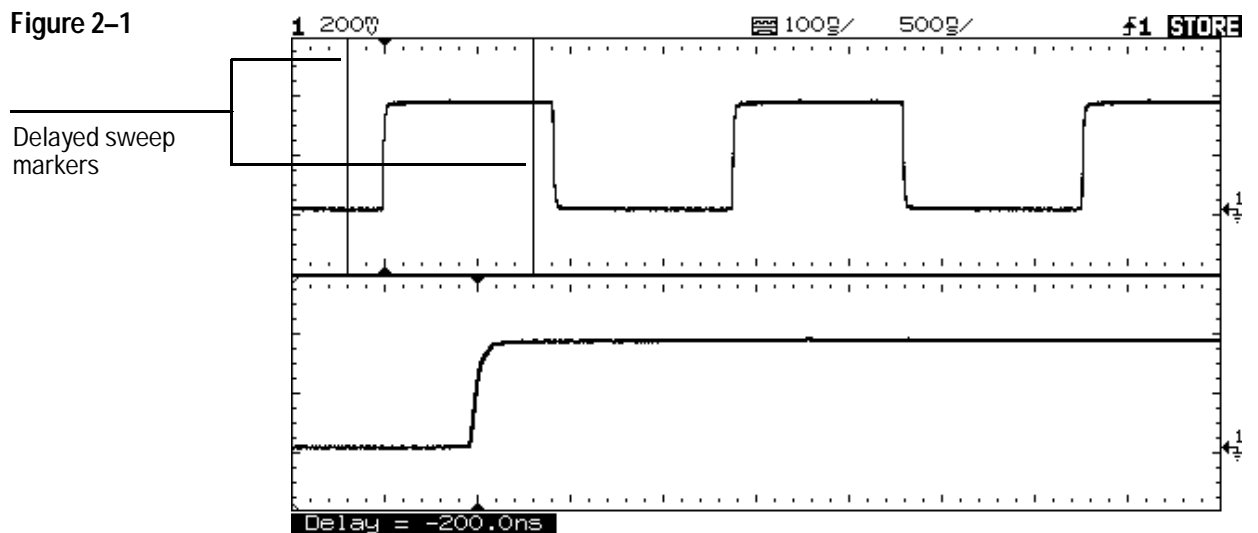

Time reference set to left

Figure 2-2 shows the time reference set to center. Notice that the markers expand around the area of interest. You can place the markers over the area of interest with the delay knob, then expand the delayed sweep with the time base knob to increase the resolution.

Figure 2-2

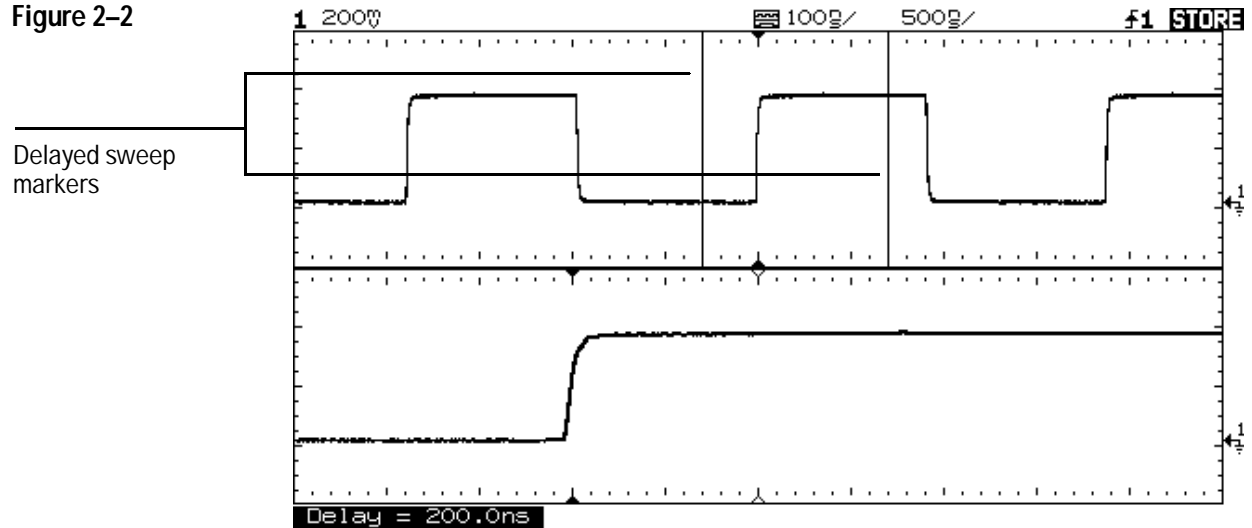

Time reference set to center

To use storage oscilloscope operation

There are four front-panel storage keys. They are white instant action keys that change the operating mode of the oscilloscope. The following steps demonstrate how to use these storage keys.

- 1 Connect a signal to the oscilloscope and obtain a stable display.
- 2 Press **Autostore** .

Notice that **STORE** replaces **RUN** in the status line.

For easy viewing, the stored waveform is displayed in half bright and the most recent trace is displayed in full bright. Autostore is useful in a number of applications.

- Displaying the worst-case extremes of varying waveforms
- Capturing and storing a waveform
- Measuring noise and jitter
- Capturing events that occur infrequently

3 Using the position knob, move the trace up and down about one division.

Notice that the last acquired waveform is in full bright and the previously acquired waveforms are displayed in half bright.

- To characterize the waveforms, use the cursors. See "To make cursor measurements" on page 2-22.
- To clear the display, press **Erase** .
- To exit the Autostore mode, press either **Run** or **Autostore** .

Summary of storage keys

Run – The oscilloscope acquires data and displays the most recent trace.

Stop – The display is frozen.

Autostore – The oscilloscope acquires data, displaying the most recent trace in full bright and previously acquired waveforms in half bright.

Erase – Clears the display.

To capture a single event

To capture a single event, you need some previous knowledge of the signal in order to set up the trigger level and slope. For example, if the event is derived from TTL logic, a trigger level of 2 volts should work on a rising edge. The following steps show you how to use the oscilloscope to capture a single event.

- 1** Connect a signal to the oscilloscope.
- 2** Set up the trigger.
 - Press **Source** . Select a trigger source with the softkeys.
 - Press **Slope/Coupling** . Select a trigger slope with the softkeys.
 - Turn the Level knob to a point where you think the trigger should work.
- 3** Press **Mode** , then press the **Single** softkey.
- 4** Press **Erase** to clear previous measurements from the display.
- 5** Press **Run** .

Pressing **Run** arms the trigger circuit. When the trigger conditions are met, data appears on the display representing the data points that the oscilloscope obtained with one acquisition. Pressing the Run key again rearms the trigger circuit and erases the display.

6 If you need to compare several single-shot events, press **Autostore** .

Like the **Run** key, **Autostore** also arms the trigger circuit. When the trigger conditions are met, the oscilloscope triggers. Pressing **Autostore** again rearms the trigger circuit, but this time the display is not erased. All the data points are retained on the display in half bright with each trigger allowing you to easily compare a series of single-shot events.

After you have acquired a single-shot event, pressing a front-panel key, softkey, or changing a knob can erase the event from the display. If you press **Stop** , the oscilloscope will recover the event and restore the oscilloscope settings.

- To clear the display, press **Erase** .
- To exit the Autostore mode, press either **Run** or **Autostore** . Notice that **RUN** replaces **STORE** in the status line, indicating that the oscilloscope has exited the Autostore mode.

Operating hint

The single-shot bandwidth is 2 MHz for single-channel operation, and 1 MHz for two-channel operation. There are twice as many sample points per waveform on the one-channel acquisition than on the two-channel acquisition. On the HP 54600B and HP 54603B, channels 1 and 2 are captured simultaneously. On the HP 54601B and HP 54602B channels 1 and 2 are captured simultaneously, then on the next trigger channels 3 and 4 are captured simultaneously.

To capture glitches or narrow pulses

A glitch is a rapid change in the waveform that is usually narrow as compared to the waveform. This oscilloscope has two modes of operation that you can use for glitch capture: peak detect and Autostore.

- 1 Connect a signal to the oscilloscope and obtain a stable display.**
- 2 Find the glitch.**

Use peak detect for narrow pulses or glitches that require sweep speeds slower than 50 $\mu\text{s}/\text{div}$.

- To select peak detect, press **Display** . Next, press the **Peak Det** softkey.

Peak detect operates at sweep speeds from 5 s/div to 50 $\mu\text{s}/\text{div}$. When operating, the initials Pk are displayed in the status line in inverse video. At sweep speeds faster than 50 $\mu\text{s}/\text{div}$, the Pk initials are not displayed in inverse video, which indicates that peak detect is not operating.

Use Autostore for the following cases: waveforms that are changing, waveforms that you want to view and compare with stored waveforms, and narrow pulses or glitches that occur infrequently but require the use of sweep speeds outside the range of peak detect.

- Press **Autostore** .

You can use peak detect and Autostore together. Peak detect captures the glitch, while Autostore retains the glitch on the display in half bright video.

3 Characterize the glitch with delayed sweep.

Peak detect functions in the main sweep only, not in the delayed sweep. To characterize the glitch with delayed sweep follow these steps.

- Press **Main/Delayed** . Next press the **Delayed** softkey.
- To obtain a better resolution of the glitch, expand the time base.
- To set the expanded portion of the main sweep over the glitch, use the Delay knob.
- To characterize the glitch, use the cursors or the automatic measurement capabilities of the oscilloscope.

To trigger on a complex waveform

The difficulty in viewing a complex waveform is triggering on the signal. Figure 2-3 shows a complex waveform that is not synchronized with the trigger.

The simplest trigger method is to trigger the oscilloscope on a sync pulse that is associated with the waveform. See "To trigger the oscilloscope" on page 1-14. If there is no sync pulse, use the following procedure to trigger on a periodic complex waveform.

- 1 Connect a signal to the oscilloscope.**
- 2 Set the trigger level to the middle of the waveform.**
- 3 Adjust the Holdoff knob to synchronize the trigger of the oscilloscope with the complex waveform.**

By setting the Holdoff to synchronize the trigger, the oscilloscope ignores the trigger that results in figure 2-3, and waits for the trigger that results in figure 2-4. Also notice in figure 2-3 that the trigger is stable, but the waveform is not synchronized with the trigger.

Holdoff operating hints

- 1** The advantage of digital holdoff is that it is a fixed number. As a result, changing the time base settings does not affect the holdoff number; so, the oscilloscope remains triggered. In contrast, the holdoff in analog oscilloscopes is a function of the time base setting making it necessary to readjust the holdoff each time you change the time base setting.
- 2** The rate of change of the holdoff adjustment knob depends on the time base setting you have selected. If you need a lengthy holdoff setting, increase the time/div setting on the time base, then make your coarse holdoff adjustment. Now switch back to the original time/div setting and make the fine adjustment to reach the exact amount you want.

Figure 2-3

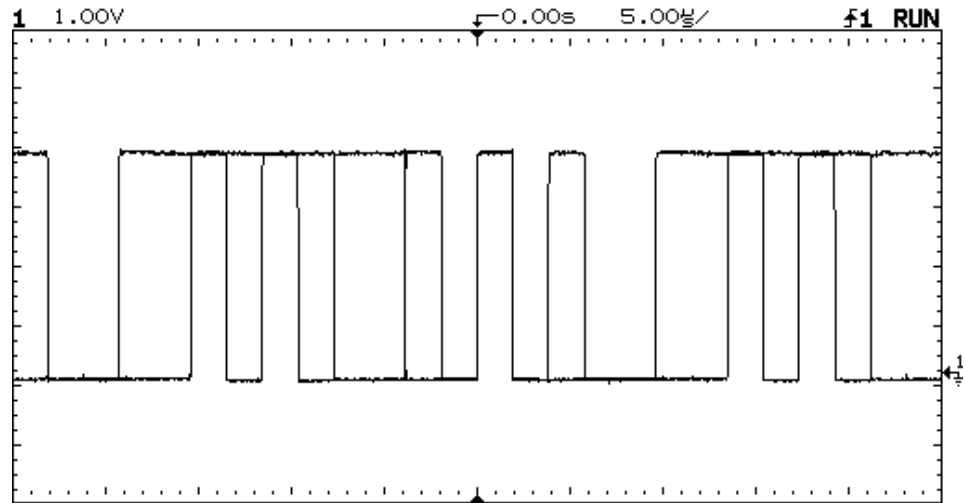

Stable trigger, but the waveform is not synchronized with the trigger

Figure 2-4

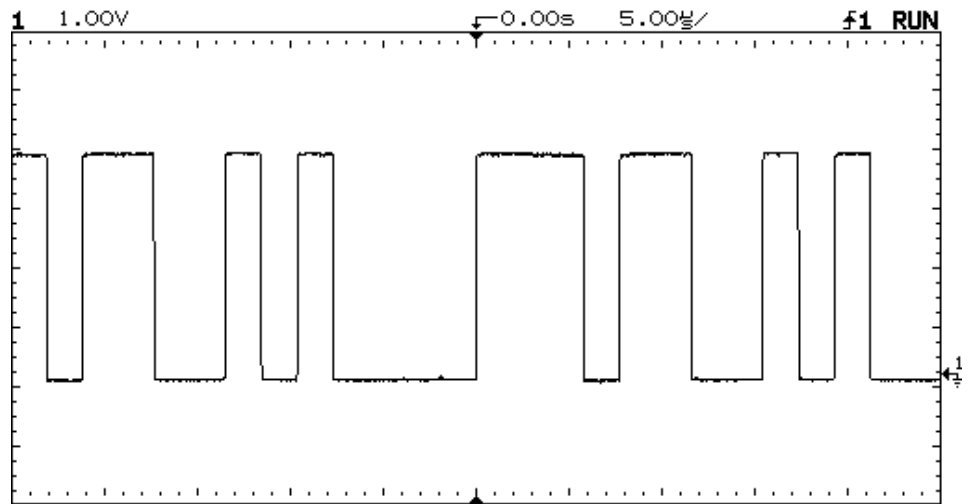

Holdoff synchronizes the waveform with the trigger

In figure 2-4, the holdoff is set to about 25 μ s (the duration of the pattern.)

To make frequency measurements automatically

The automatic measurement capability of the oscilloscope makes frequency measurements easy, as the following steps demonstrate.

- 1** Connect a signal to the oscilloscope and obtain a stable display.
- 2** Press **Time** .

A softkey menu appears with six softkey choices.

- 3** Toggle the **Source** softkey to select a channel for the frequency measurement.
- 4** Press the **Freq** softkey.

The oscilloscope automatically measures the frequency and displays the result on the lower line of the display. The number in parentheses after the word **Freq** is the number of the channel that the oscilloscope used for the measurement. The oscilloscope retains in memory and displays the three most current measurement results. If you make a fourth measurement, the left-most result is dropped

If the **Show Meas** softkey is turned on, cursors are displayed on the waveform that show the measurement points for the right-most measurement result. If you select more than one measurement, you can show a previous measurement by reselecting the measurement.

- To find the **Show Meas** softkey, press the **Next Menu** softkey key.
The oscilloscope makes automatic measurements on the first displayed event. Figure 2-5 shows how to use delayed sweep to isolate an event for a frequency measurement. If the measurement is not possible in the delayed time base mode, then the main time base is used. If the waveform is clipped, it may not be possible to make the measurement.

Figure 2-5

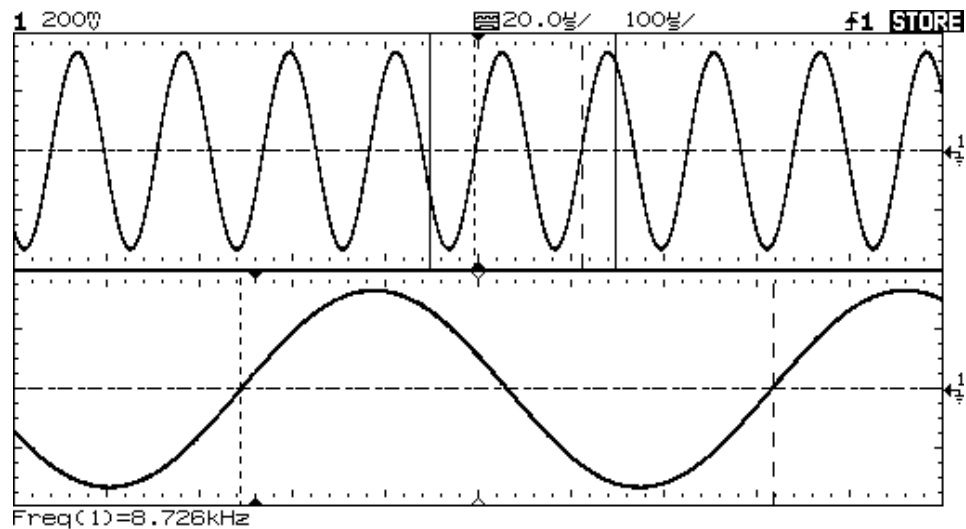

Delayed time base isolates an event for a frequency measurement

To make time measurements automatically

You can measure the following time parameters with the oscilloscope: frequency, period, duty cycle, width, rise time, and fall time. The following exercise guides you through the Time keys by making a rise time measurement. Figure 2-6 shows a pulse with some of the time measurement points.

1 Connect a signal to the oscilloscope and obtain a stable display.

When the signal has a well-defined top and bottom (see figure 2-8), the rise time and fall time measurements are made at the 10% and 90% levels. If the oscilloscope cannot find a well-defined top or bottom (see figure 2-9), the maximum and minimum levels are used to calculate the 10% and 90% points.

Figure 2-6

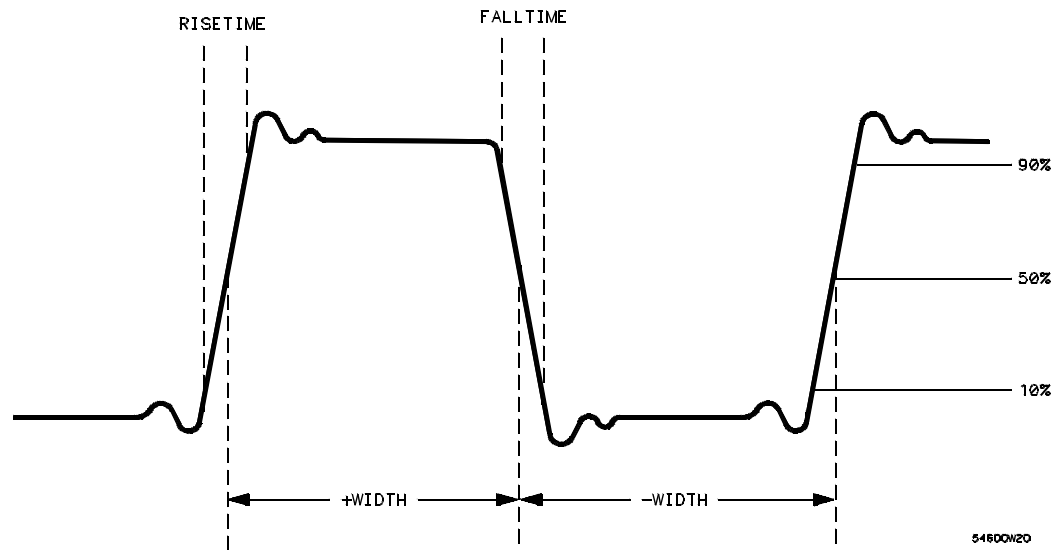

Time Measurement Points

2 Press **Time** .

A softkey menu appears with six softkey choices. Three of the softkeys are time measurement functions.

Source Selects a channel for the time measurement.

Time Measurements Three time measurement choices are available: Freq (frequency), Period, and Duty Cy (duty cycle). These measurements are made at the 50% levels. Refer to figure 2-6.

Clear Meas (clear measurement) Erases the measurement results and removes the cursors from the display.

Next Menu Replaces the softkey menu with six additional softkey choices.

3 Press the **Next Menu** softkey.

Another time measurement softkey menu appears with six additional choices. Four of the softkeys are time measurement functions.

Show Meas (show measurement) Displays the horizontal and vertical cursors where the measurement was taken.

Operating Your Oscilloscope

To make time measurements automatically

Time Measurements Four additional time measurement choices are available; +Width, –Width, Rise time, and Fall time. Width measurements are made at the 50% levels, whereas rise time and fall time measurements are made at the 10% to 90% levels.

Previous Menu Returns to the previous softkey menu.

4 Press the Rise Time softkey.

The oscilloscope automatically measures the rise time of the signal and displays the result on the display.

The oscilloscope makes automatic measurements on the first displayed event. Figure 2-7 shows how to use delayed sweep to isolate an edge for a rise time measurement.

Figure 2-7

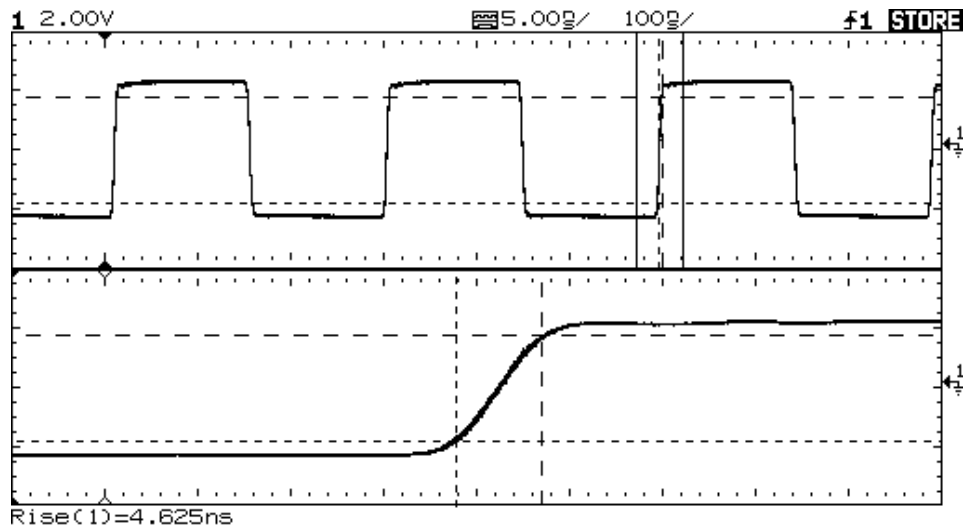

Delayed sweep isolates a leading edge for a rise time measurement

To make voltage measurements automatically

You can measure the following voltage parameters automatically with the oscilloscope: peak-to-peak, average, rms, maximum, minimum, top, and base. The following exercise guides you through the Voltage keys by making an rms voltage measurement. Figures 2-8 and 2-9 show pulses with some of the voltage measurement points.

Figure 2-8

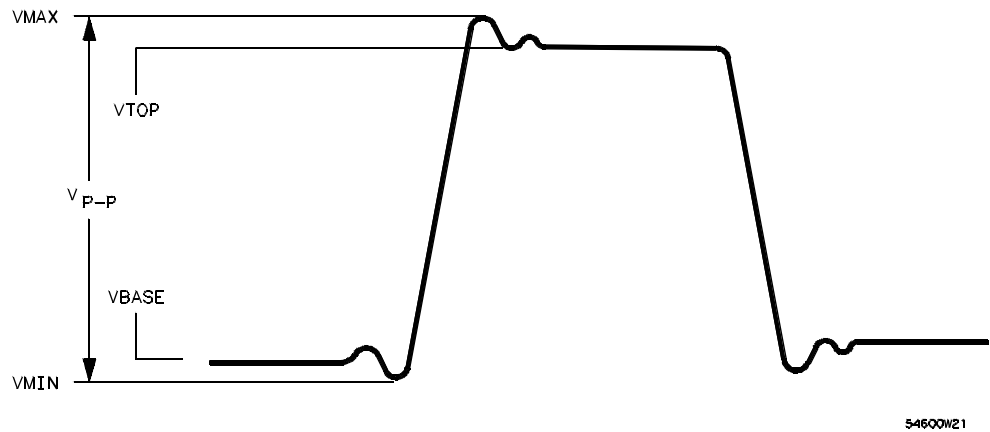

Pulse where the top and bottom are well-defined

Figure 2-9

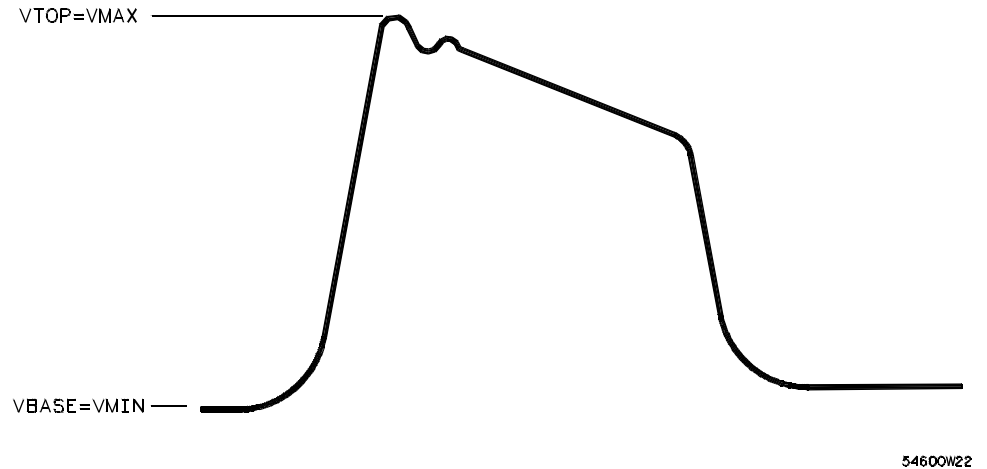

Pulse where the top and bottom are not well-defined

Operating Your Oscilloscope
To make voltage measurements automatically

1 Connect a signal to the oscilloscope and obtain a stable display.

2 Press **Voltage**.

A softkey menu appears with six softkey choices. Three of the softkeys are voltage measurement functions.

Source Selects a channel for the voltage measurement.

Voltage Measurements Three voltage measurement choices are available: V_{p-p} , V_{avg} , and V_{rms} . The measurements are determined by voltage histograms of the signal.

Clear Meas (clear measurement) Erases any measurement results from the display, and removes the horizontal and vertical cursors from the display.

Next Menu Replaces the softkey menu with six additional softkey choices.

3 Press the **V_{rms}** softkey.

The oscilloscope automatically measures the rms voltage and displays the result on the display.

The oscilloscope makes automatic measurements on the first pulse or period in the display. Figure 2-10 shows how to use delayed sweep to isolate a pulse for an rms measurement.

Figure 2-10

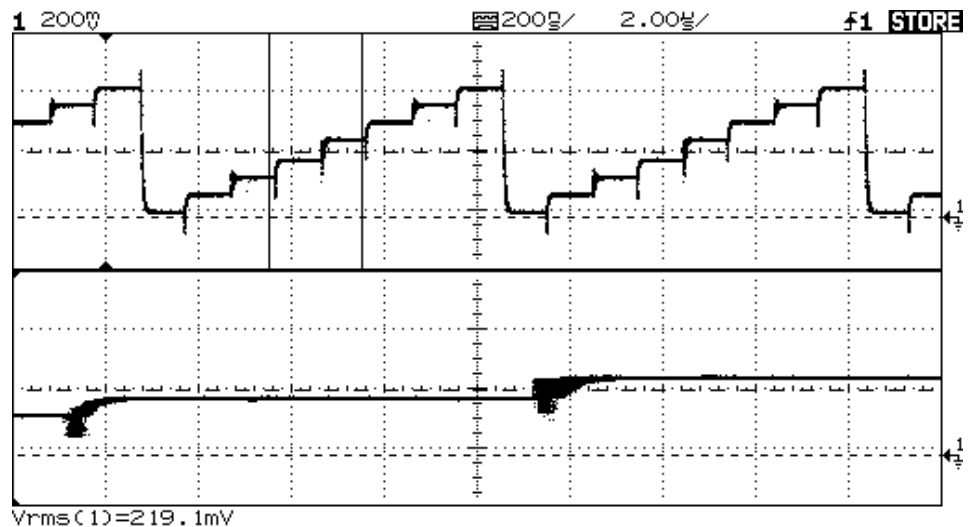

Delayed sweep isolates an area of interest for an rms voltage measurement

4 Press the Next Menu softkey.

Another voltage measurement softkey menu appears with six additional choices. Four of the softkeys are voltage measurement functions.

Show Meas (show measurement) Displays the horizontal and vertical cursors that show where the measurement was taken on the signal.

Voltage Measurements Four additional voltage measurement choices are available: V_{max} , V_{min} , V_{top} , V_{base} .

Previous Menu Returns to the previous softkey menu.

To make cursor measurements

The following steps guide you through the front-panel **Cursors** key. You can use the cursors to make custom voltage or time measurements on the signal. Examples of custom measurements include rise time measurements from reference levels other than 10-90%, frequency and width measurements from levels other than 50%, channel-to-channel delay measurements, and voltage measurements. See figures 2-11 through 2-16 for examples of custom measurements.

- 1 Connect a signal to the oscilloscope and obtain a stable display.
- 2 Press **Cursors** .

A softkey menu appears with six softkey choices. Four of the softkeys are cursor functions.

Source Selects a channel for the voltage cursor measurements.

Active Cursor There are four cursor choices: V1, and V2 are voltage cursors, while t1, and t2 are time cursors. Use the knob below the Cursors key to move the cursors. When you press the V1 and V2 softkeys simultaneously or the t1 and t2 softkeys simultaneously, the cursors move together.

Clear Cursors Erases the cursor readings and removes the cursors from the display.

Figure 2-11

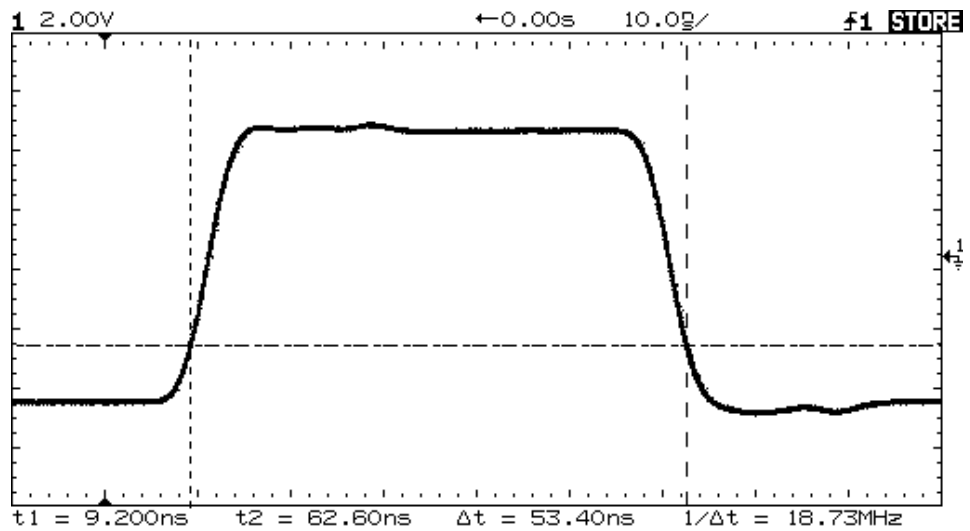

Cursors used to measure pulse width at levels other than the 50% points

Figure 2-12

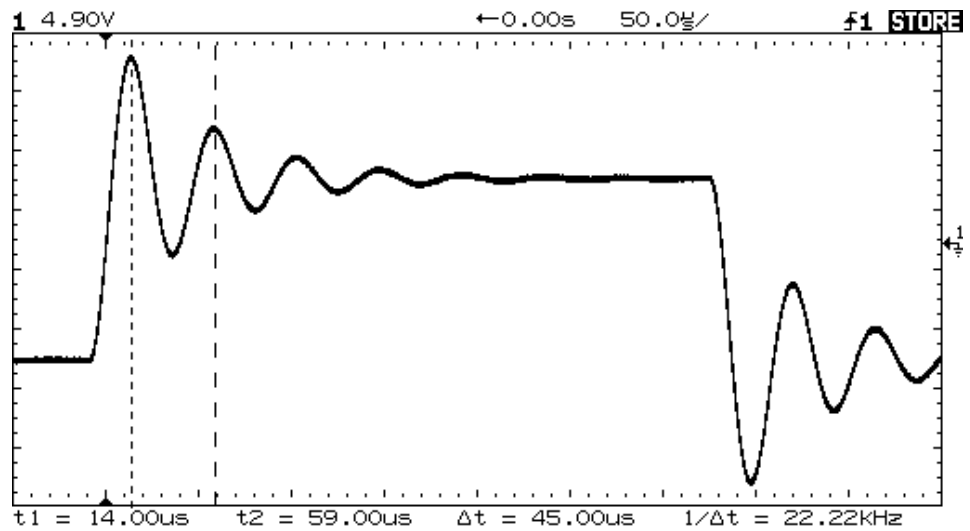

Cursors used to measure the frequency of the ringing on a pulse

Operating Your Oscilloscope
To make cursor measurements

Figure 2-13

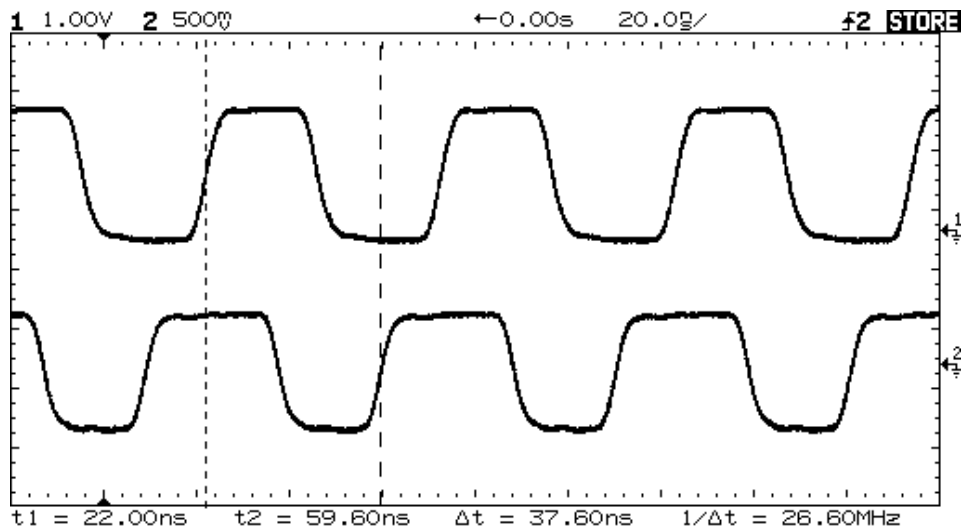

Cursors used to make channel-to-channel delay measurements

Figure 2-14

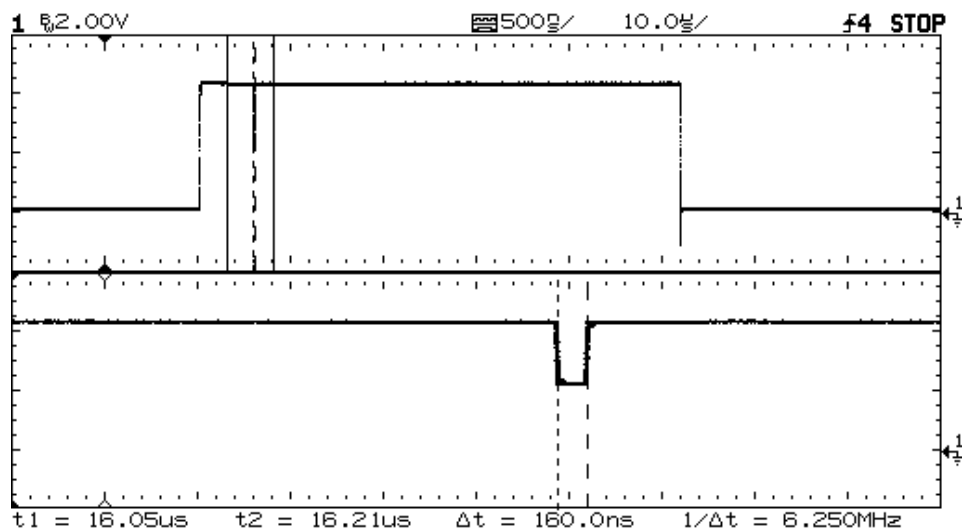

The cursors track delayed sweep. Expand the display with delayed sweep, then characterize the event of interest with the cursors.

Figure 2-15

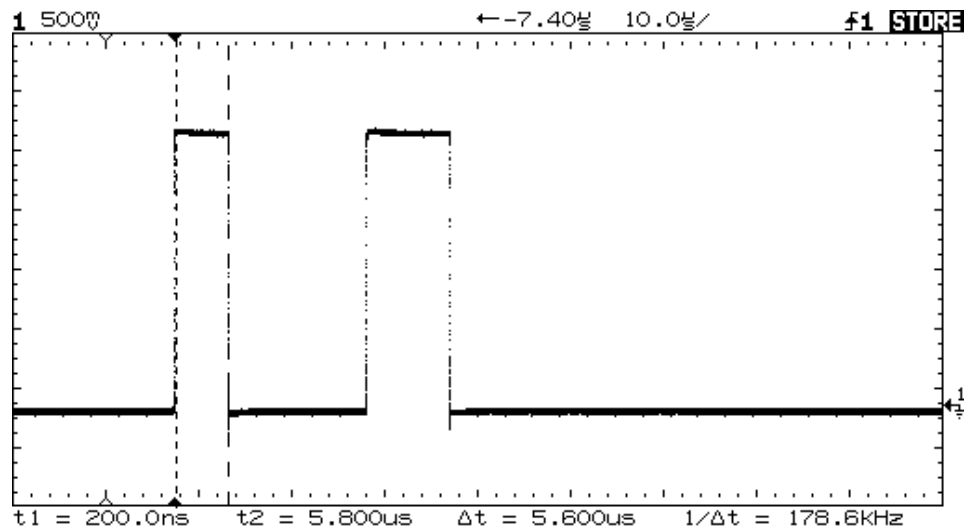

Pressing t1 and t2 softkeys simultaneously causes the cursors to move together when the cursor knob is adjusted.

Figure 2-16

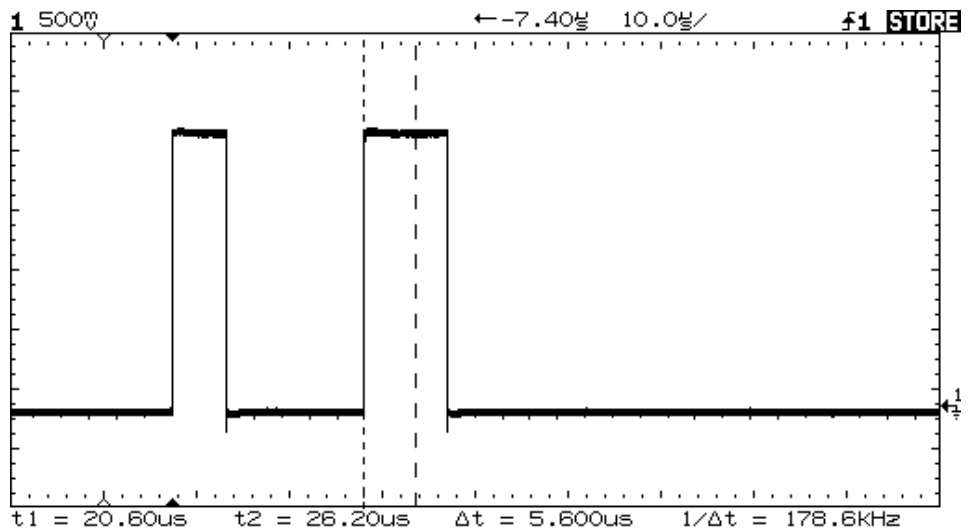

By moving the cursors together, you can check for pulse width variations in a pulse train, as figures 2-15 and 2-16 show.

To view asynchronous noise on a signal

The following exercise shows how to use the oscilloscope to view asynchronous noise on a signal that is not synchronous to the period of the waveform.

- 1 Connect a noisy signal to the oscilloscope and obtain a stable display.

Figure 2-17 shows a waveform with asynchronous noise at the top of the pulse.

Figure 2-17

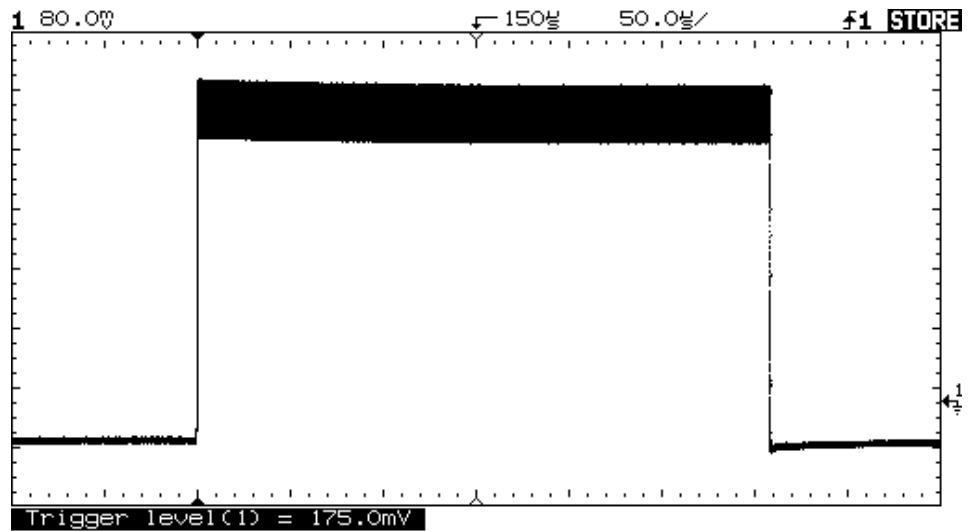

Asynchronous noise at the top of the pulse

2 Press **Autostore** .

Notice that **STORE** is displayed in the status line.

3 Set the trigger mode to normal, then adjust the trigger level into the noise region of the signal.

4 Decrease the sweep speed for better resolution of the asynchronous noise.

- To characterize the asynchronous noise signal, use the cursors.

Figure 2-18

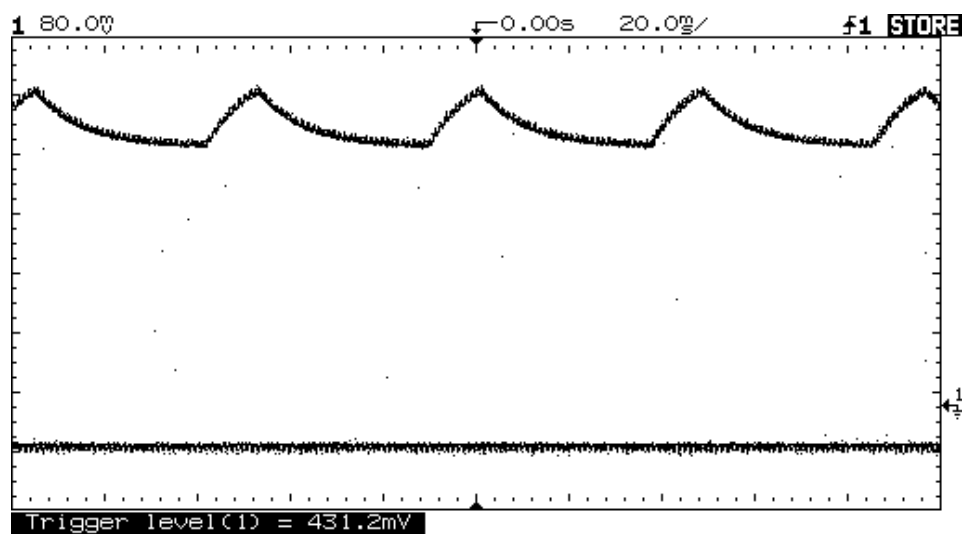

This is a triggered view of the asynchronous noise shown in Figure 2-17

To reduce the random noise on a signal

If the signal you are applying to the oscilloscope is noisy (figure 2-21), you can set up the oscilloscope to reduce the noise on the waveform (figure 2-22). First, you stabilize the displayed waveform by removing the noise from the trigger path. Second, you reduce the noise on the displayed waveform.

- 1 Connect a signal to the oscilloscope and obtain a stable display.
- 2 Remove the noise from the trigger path by turning on either high frequency reject or noise reject.

High frequency reject (HF reject) adds a low pass filter with the 3 dB point at 50 kHz (see figure 2-19). You use HF reject to remove high frequency noise such as AM or FM broadcast stations from the trigger path.

Figure 2-19

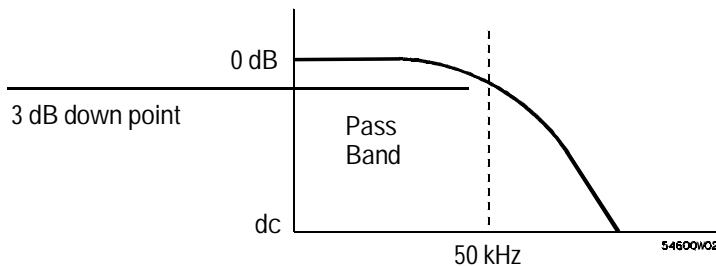

HF reject

Low frequency reject (LF reject) adds a high pass filter with the 3-dB point at 50 kHz (see figure 2-20). Use LF reject to remove low frequency signals such as power line noise from the trigger path.

Figure 2-20

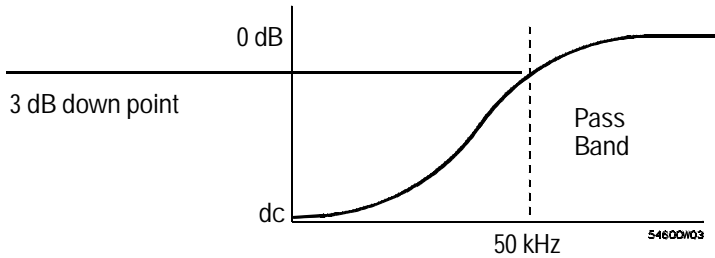

LF reject

Noise reject increases the trigger hysteresis band. By increasing the trigger hysteresis band you reduce the possibility of triggering on noise. However, this also decreases the trigger sensitivity so that a slightly larger signal is required to trigger the oscilloscope.

Figure 2-21

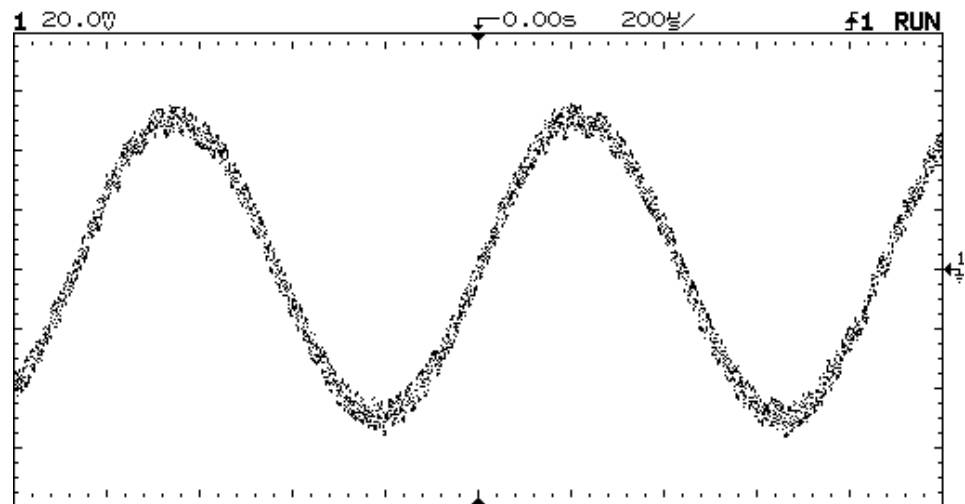

Random noise on the displayed waveform

Operating Your Oscilloscope
To reduce the random noise on a signal

3 Use averaging to reduce noise on the displayed waveform.

To use averaging follow these steps.

- Press **Display** , the press the **Average** softkey.

Notice that **AV** appears in the status line.

- Toggle the **# Average** softkey to select the number of averages that best eliminates the noise from the displayed waveform.

The **AV** initials in the status line indicates how much of the averaging process is finished, by turning to inverse video as the oscilloscope performs averaging. The higher the number of averages, the more noise that is removed from the display. However, the higher the number of averages, the slower the displayed waveform responds to waveform changes. You need to choose between how quickly the waveform responds to changes and how much noise there is on the signal.

Figure 2-22

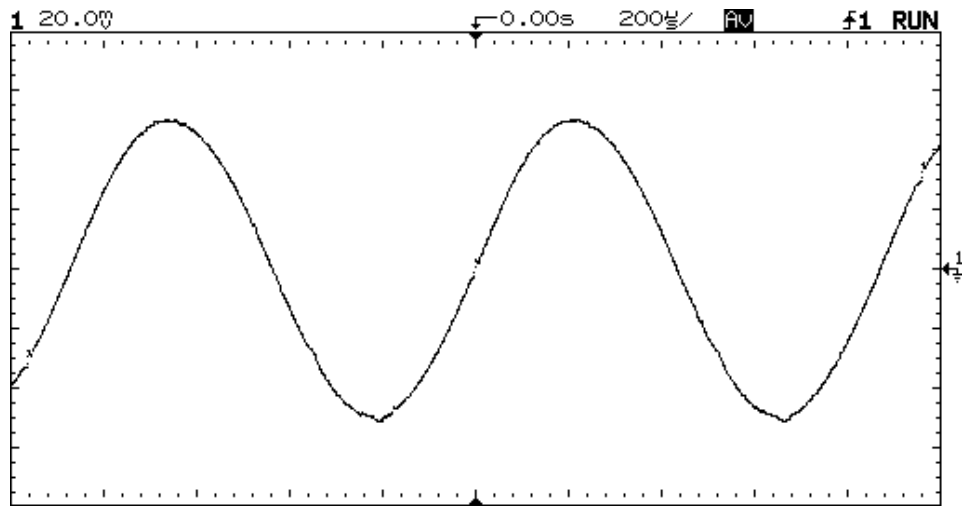

On this waveform, 256 averages were used to reduce the noise

To save or recall traces

The oscilloscope has two pixel memories for storing waveforms. The following exercise guides you through how to store and recall waveforms from pixel memories.

1 Connect a signal to the oscilloscope and obtain a stable display.

2 Press **Trace**.

A softkey menu appears with five softkey selections. Four of the softkeys are trace memory functions.

Trace Selects memory 1 or memory 2.

Trace Mem Turns on or off the selected memory.

Save to Saves the waveform to the selected memory. The front-panel setup is saved to a separate memory location.

Clear Erases the selected memory.

Recall Setup Recalls the front-panel setup that was saved with the waveform.

3 Toggle the **Trace** softkey to select memory 1 or memory 2.

4 Press the **Save to** softkey.

The current display is copied to the selected memory.

5 Turn on the **Trace Mem** softkey to view the stored waveform.

The trace is copied from the selected trace memory and is displayed in half bright video.

Operating Your Oscilloscope

To save or recall front-panel setups

The automatic measurement functions do not operate on stored traces. Remember, the stored waveforms are pictorial information rather than stored data.

- If you have not changed the oscilloscope setup, use the cursors to make the measurements.
- If you have changed the oscilloscope setup, press the **Recall Setup** softkey. Then, use the cursors to make the measurements.

Trace memory operating hint

The standard oscilloscope has volatile trace memories. When you add an interface module to the oscilloscope, the trace memories become nonvolatile.

To save or recall front-panel setups

There are 16 memories for storing front-panel setups. Saving front-panel setups can save you time in situations where several setups are repeated many times.

- 1 Press **Setup**.
- 2 To change the selected memory location, press either the left-most softkey or turn the knob closest to the Cursors key.
- 3 Press the **Save** softkey to save a front-panel setup, then press the **Recall** softkey to recall a front-panel setup.

To reset the instrument setup

- 1 To reset the instrument to the default factory-preset configuration, press **Setup** .
- 2 Press the **Default Setup** softkey.
- 3 To reset the instrument to the configuration that was present before pressing **Autoscale**, press the **Undo Autoscale** softkey.

Table 2-1

Default Setup configuration settings

Configuration Item	Setting
Cursors	Cursors off; time readout is selected; all cursors are set to time/voltage zero.
Trace memories	Both trace memory 1 and 2 are off; trace 1 memory is selected.
Setup memories	Setup memories are off; setup memory 1 is selected.
Graticule	Grid set to Full
Autostore	Off
Time base	Time reference center; main, not delayed sweep; main and delay value 0; 100 μ s/div main time base.
Display	Vectors On, Display Mode Normal.
Channels	Channel 1 on, Position 0 V, Volts/Div 100 mV.
Trigger Mode	Auto Level, Coupling DC, Reject Off, Noise Reject Off.
Trigger Condition	Rising edge of channel 1

To use the XY display mode

The XY display mode converts the oscilloscope from a volts versus time display to a volts versus volts display. You can use various transducers so the display could show strain versus displacement, flow versus pressure, volts versus current, or voltage versus frequency. This exercise shows a common use of the XY display mode by measuring the phase shift between two signals of the same frequency with the Lissajous method.

- 1 Connect a signal to channel 1, and a signal of the same frequency but out of phase to channel 2.
- 2 Press **Autoscale** , press **Main/Delayed** , then press the **XY** softkey.
- 3 Center the signal on the display with the Position knobs, and use the Volts/Div knobs and the vertical Vernier softkeys to expand the signal for convenient viewing.

$\sin \theta = \frac{A}{B}$ or $\frac{C}{D}$, where θ = phase shift (in degrees) between the two signals.

Figure 2-23

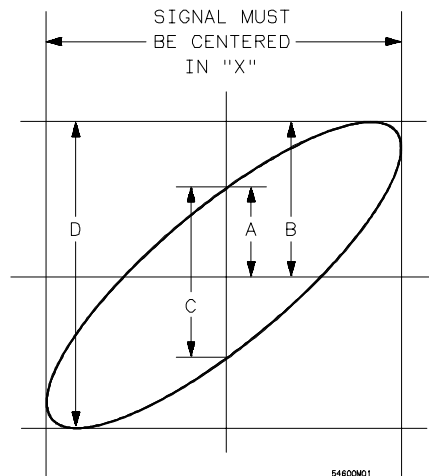

Phase shift Parameters

XY display mode operating hint

Before entering XY display mode, center both channels on screen in the main sweep and adjust sweep speed to obtain greater than or equal to 1 cycle of the lowest frequency input signal on screen.

When you select the XY display mode, the time base is turned off. Channel 1 is the X-axis input, channel 2 is the Y-axis input, and channel 4 (external trigger in the HP 54600B and HP 54603B) is the Z-axis input. If you only want to see portions of the Y versus X display, use the Z-axis input. Z-axis turns on and off the trace (analog oscilloscopes called this Z-blanking because it turned the beam on and off). When Z is low (<1.3 V), Y versus X is displayed; when Z is high (>1.3 V), the trace is turned off.

- 4 Press **Cursors** .
- 5 Set the Y2 cursor to the top of the signal, and set Y1 to the bottom of the signal.

Note the ΔY value at the bottom of the display. In this example we are using the Y cursors, but you could have used the X cursors instead. If you use the X cursors, make sure you center the signal in the Y axis.

Figure 2-24

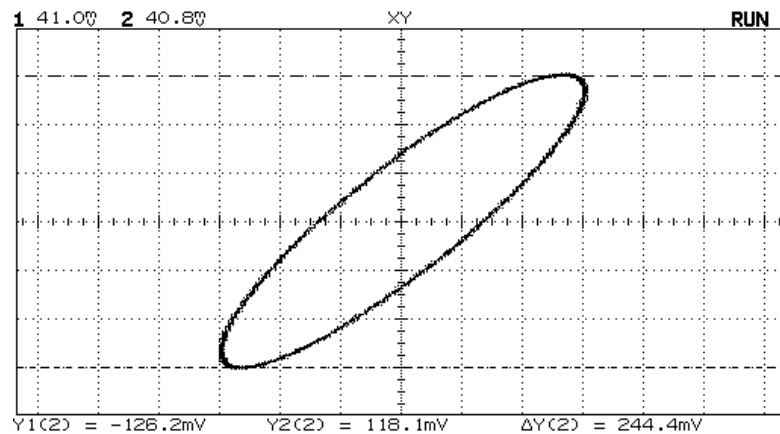

XY Display with Cursors On

Operating Your Oscilloscope
To use the XY display mode

6 Move the Y1 and Y2 cursors to the center of the signal.

Again, note the ΔY value.

Figure 2-25

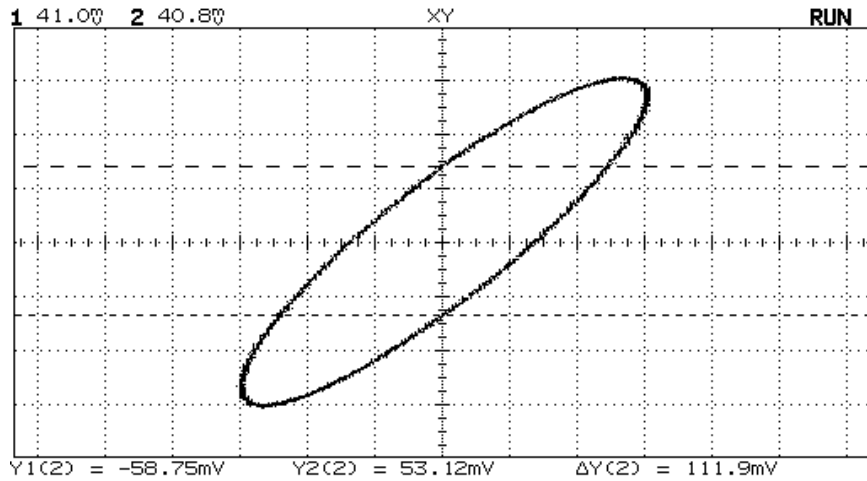

Y cursors centered

7 Calculate the phase difference using formula below.

$$\sin \theta = \frac{\text{second } \Delta Y}{\text{first } \Delta Y} = \frac{111.9}{244.4} = 27.25 \text{ degrees of phase shift.}$$

Figure 2-26

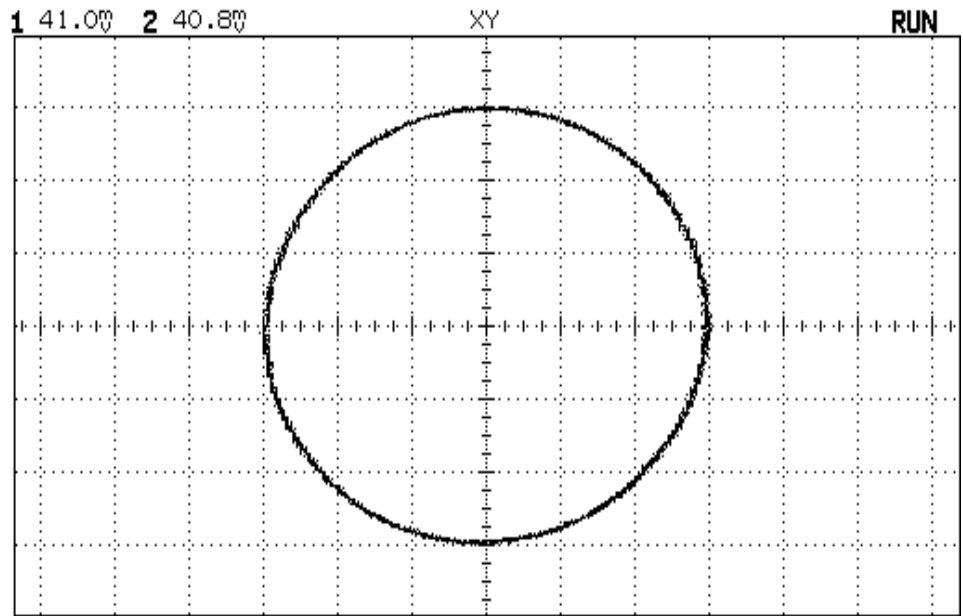

Signals are 90° out of phase

Figure 2-27

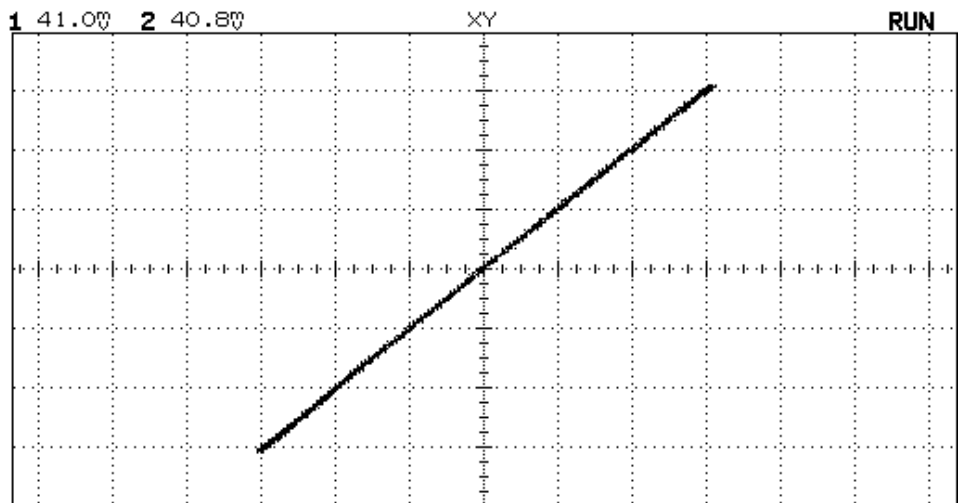

Signals are in phase

To analyze video waveforms

Enhanced TV/Video Trigger (HP 54602B only)

This section discusses basic TV video triggering. If you have Option 005 Enhanced TV/Video Trigger installed in your HP 54602B oscilloscope, refer to Chapter 3 "Using Option 005 Enhanced TV/Video Trigger."

The TV sync separator in the oscilloscope has an internal clamp circuit. This removes the need for external clamping when you are viewing unclamped video signals. TV triggering requires two vertical divisions of display, either channel 1 or channel 2 as the trigger source, and the selection of internal trigger. Turning the trigger level knob in TV trigger does not change the trigger level because the trigger level is automatically set to the sync pulse tips.

For this exercise we connected the oscilloscope to the video output terminals on a television. Then we set up the oscilloscope to view these parts of a TV signal: the second vertical interval with delayed sweep windowed on the vertical interval test signals (VITS) and the IRE displayed full screen.

- 1 Connect a TV signal to channel 1, then press **Autoscale** .
- 2 Press **Display** , then press the **Peak Det** softkey.
- 3 Press **Mode** , then press the **TV** softkey.
- 4 Press **slope/Coupling** , then press the **Field 2** softkey.

Polarity Selects either positive or negative sync pulses.

Field 1 Triggers on the field 1 portion of the video signal.

Field 2 Triggers on the field 2 portion of the video signal.

Line Triggers on all the TV line sync pulses.

HF Rej Controls a 500 kHz low pass filter in the trigger path.

- 5 Set the time base to $200\ \mu\text{s}/\text{div}$, then center the signal on the display with the delay knob (delay about $800\ \mu\text{s}$).
- 6 Press **Main/Delayed** , then press the **Delayed** softkey.
- 7 Set the delayed sweep to $20\ \mu\text{s}/\text{div}$, then set the expanded portion over the VITS (delay about $988.8\ \mu\text{s}$).

Figure 2-28

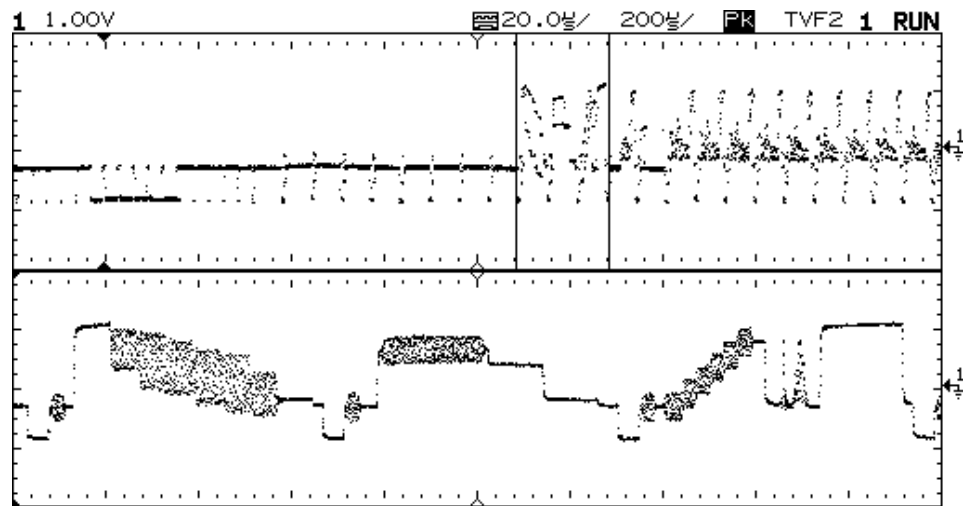

Second vertical interval windowed on the VITS

Operating Your Oscilloscope
To analyze video waveforms

- 8 Press **Main/Delayed** , then press the **Main** softkey.
- 9 Use the horizontal vernier to change the time base to $7\ \mu\text{s}/\text{div}$, then center the signal on the display with the delay knob (delay about $989\ \mu\text{s}$).

Figure 2-29

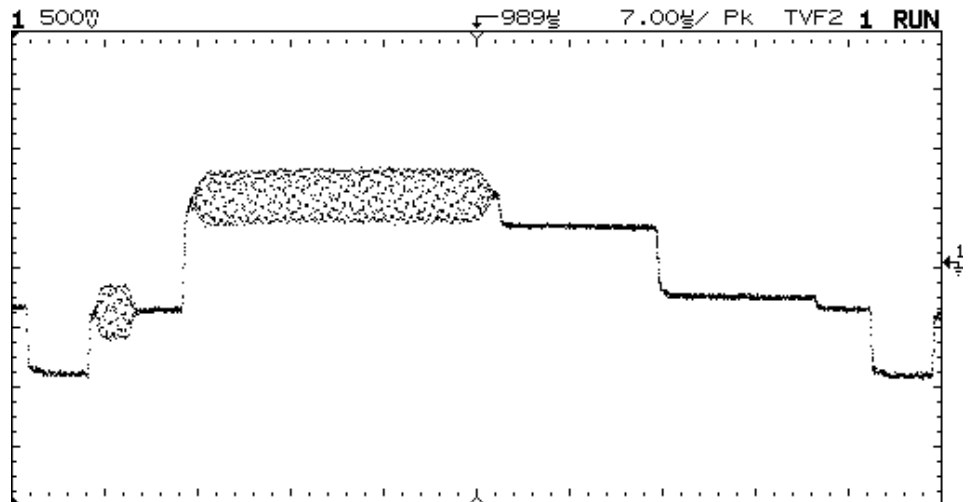

Full screen display of the IRE

Delay in TV line units hint

HP 54600B-series oscilloscopes with system ROM versions 2.1 and greater have the ability to display delay in TV-line units. Using the TV field trigger mode activates this line-counting feature. When Field 1 or Field 2 is selected as the trigger source, delay can be set in terms of time or line number.

Both-fields triggering hint

The HP 54600B-series oscilloscopes can trigger on the vertical sync pulse in both TV fields at the same time. This allows you to view noninterlaced video signals which are common in today's computer monitors. To trigger on both sync pulses, press Field 1 and Field 2 at the same time.

TV trigger operating hints

The color burst never really changes phase, it just looks doubled triggered because its frequency is an odd multiple of one half the line frequency.

When looking at live video (usually a field), use peak detect to improve the appearance of the display.

When making cursor measurements, use Autostore since you are usually looking for pulse flatness and extremes.

When using line trigger, use minimum holdoff to display all the lines. Due to the relationship between the horizontal and vertical sync frequencies the display looks like it is untriggered, but it is very useful for TV waveform analysis and adjustment because all of the lines are displayed.

Using Option 005 Enhanced TV/Video Trigger (HP 54602B)

Using Option 005 Enhanced TV/Video Trigger

Basic TV/video triggering

This section discusses Enhanced TV/Video triggering. If you do not have Option 005 installed in your oscilloscope, refer to the last section in Chapter 2 "To analyze video waveforms" for basic TV triggering procedures.

You can use the Option 005 Enhanced TV/Video trigger with your HP 54602B oscilloscope. One of the first things you will want to do with your oscilloscope's new Option 005 Enhanced TV/Video trigger is to become acquainted with its menu choices. Therefore, we have written the exercises in this chapter to familiarize you with its basic controls.

To use the TV/Video trigger, you must be familiar with your oscilloscope. In summary, the front panel of the oscilloscope has knobs, grey keys, and white keys. The knobs are used most often and are similar to the knobs on other oscilloscopes. The grey keys bring up softkey menus on the display that allow you access to many of the oscilloscope features. The white keys are instant action keys and menus are not associated with them. The status line of the oscilloscope, located at the top of of the display, lets you quickly determine the setup of the oscilloscope.

When Option 005 is installed in the HP 54602B Oscilloscope, the **Display** menu has the extra **Grid** (graticule) choice of **TV**.

Option 005 gives you an Enhanced TV/Video Trigger for the oscilloscope, allowing highly detailed analysis of TV waveforms. This option offers:

- NTSC, PAL, PAL-M, SECAM and generic video formats
- Video autoscale
- IRE graticule and IRE cursor readout
- Full bandwidth rear panel output
- Trigger output
- Windowed FFT measurements (with Measurement/Storage module)

Now, in one easy-to-use instrument, you can measure your system's video performance as well as use your oscilloscope for troubleshooting and precision measurements. The oscilloscope's superior display gives you bright, easily viewed displays of any part of the video waveform. No longer do you need to use a viewing hood or to be constantly adjusting intensity and focus controls.

Analysis of video waveforms is simplified by the oscilloscope's ability to trigger on any selected line of the video signal. You can make additional measurements using the **All lines, Field 1, Field 2, All fields** (**Vertical** mode in **GENERIC** standard), or **Line** triggering modes. In addition, you can use the rear-panel, full-bandwidth signal and trigger outputs with a spectrum instrument or frequency counter for additional measurement power.

To select TV display grid

- Press **Display** , then press the **Grid** softkey until TV is selected.

To autoscale on a video signal

- 1 Use a cable to connect a TV signal to channel 1.
- 2 Press **Mode** in the TRIGGER section of the front panel, and select the **Trigger Mode TV** softkey.
- 3 To select a TV standard, press **Slope/Coupling** in the TRIGGER section of the front panel, then press the **Standard** softkey to select the TV standard. Your choices are **NTSC**, **PAL**, **SECAM**, and **GENERIC**. **GENERIC** is used for other TV/Video standards. If your TV standard has been previously selected, you may skip this step.
- 4 Press **Mode** , then press the **Video Autoscale** softkey.

Provide correct source matching

Many TV signals are produced from 75 Ω sources. To provide correct matching to these sources, an HP 11094B 75 Ω load is included as an accessory. For oscilloscopes that have selectable input impedance, the 1 M Ω input should be used with the 75 Ω load.

The **Undo Autoscale** softkey in the **Setup** menu resets the instrument to the configuration that was present before pressing **Video Autoscale**.

To trigger on a specific line of video

TV triggering requires greater than 1/4 division of sync amplitude, either channel 1 or channel 2 as the trigger source. Turning the trigger level knob in TV trigger does not change the trigger level because the trigger level is automatically set to the sync pulse tips.

One example of triggering on a specific line of video is looking at the vertical interval test signals (VITS), which are typically in line 18. Another example is closed captioning, which is typically in line 21.

- 1 Select the TV display, TV as the trigger mode, and the appropriate TV standard.
- 2 Press **Slope/Coupling** in the TRIGGER section of the front panel, then press the **Mode** softkey until **Line** appears. Select the number of the line you want to examine by pressing the **Trigger On Line** softkey or by rotating the knob closest to the **Cursors** key.
- 3 Press the **Trigger On** softkey to select the TV field of the line you want to trigger on. Your choices are **Field 1**, **Field 2**, and **Alt Fld** (alternate fields).

Alternate triggering

If **Alt Fld** is selected, the oscilloscope will alternately trigger on the selected line number in Field 1 and Field 2. This is a quick way to compare the Field 1 VITS and Field 2 VITS or to check for the correct insertion of the half line at the end of Field 1.

When using **GENERIC** as the TV standard, the **Trigger On** softkey gives you the choices of **Field 1**, **Field 2** and **Vertical**.

Using Option 005 Enhanced TV/Video Trigger (HP 54602B)
 To trigger on a specific line of video

Figure 3-1

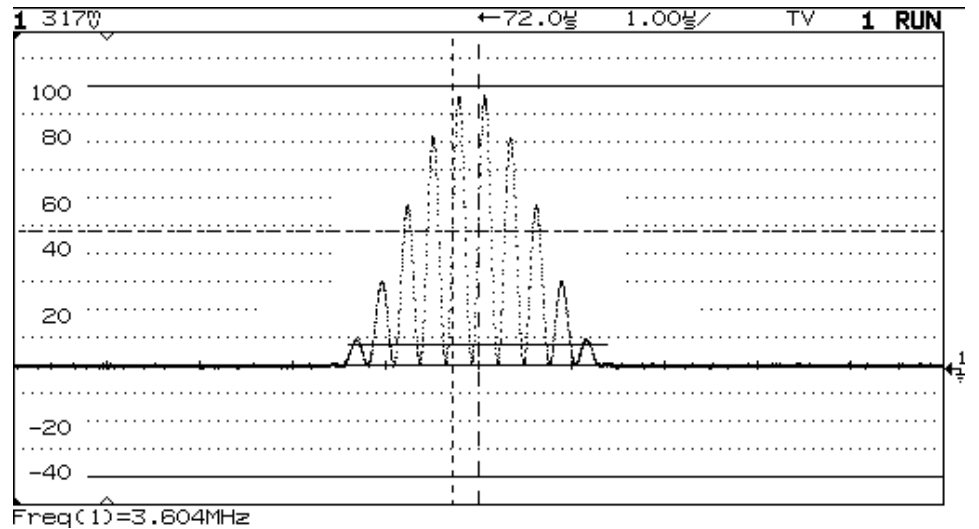

Triggering on Line 71

Table 3-1

Line Numbers per Field for Each TV Standard

TV Standard	Field 1	Field 2	Alt Fld
NTSC	1 to 263	1 to 262	1 to 262
PAL	1 to 313	314 to 625	1 to 313
PAL-M	1 to 313	314 to 625	1 to 313
SECAM	1 to 313	314 to 625	1 to 313
GENERIC	1 to 1024	1 to 1024	1 to 1024 (Vertical)

Line Number Represents Count

In **GENERIC** mode, the line number represents the number of a count instead of a real line number. This is reflected in the label above the softkey changing from **Line** to **Cnt**. In the **Trigger On** selections, **Field 1**, **Field 2** and **Vertical** are used to indicate where the counting starts. For an interlaced TV system, the counting starts from the rising edge of the first vertical serration pulse of Field 1 and/or Field 2. For a non-interlaced TV system, the counting starts after the rising edge of the vertical sync pulse.

To trigger on all TV line sync pulses

To quickly find maximum video levels, you could trigger on all TV line sync pulses. When All Lines is selected as the TV trigger mode, the oscilloscope will trigger on the first line that it finds when the acquisition starts.

- 1 Select the TV display, TV as the trigger mode, and the appropriate TV standard as described in the previous section, "To autoscale on a video signal."
- 2 Press **Slope/Coupling** in the TRIGGER section of the front panel, then press the Mode softkey until All Lines appears.

Vertical interval can be blocked

The 21 lines in the Vertical Interval can be blocked from this display if the **Vert Rej On** mode is selected. The three color sync bursts being displayed inside the white bars are on vertical interval lines. These could be removed by selection of **Vert Rej On**.

Figure 3-2

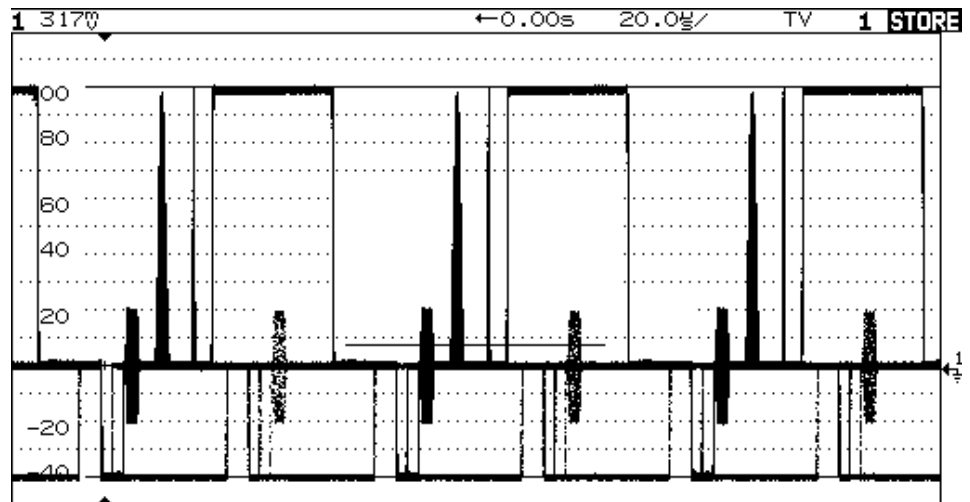

Triggering on All Lines

To trigger on a specific field of the video signal

To examine the components of a video signal, trigger on either Field 1 or Field 2. When a specific field is selected, the oscilloscope triggers on the rising edge of the first serration pulse in the vertical sync interval in the specified field (1 or 2).

- 1 Select the TV display, TV as the trigger mode, and the appropriate TV standard as described in the section, "To autoscale on a video signal."
- 2 Press **Slope/Coupling** in the TRIGGER section of the front panel, then press the Mode softkey until Field 1 or Field 2 appears.

Figure 3-3

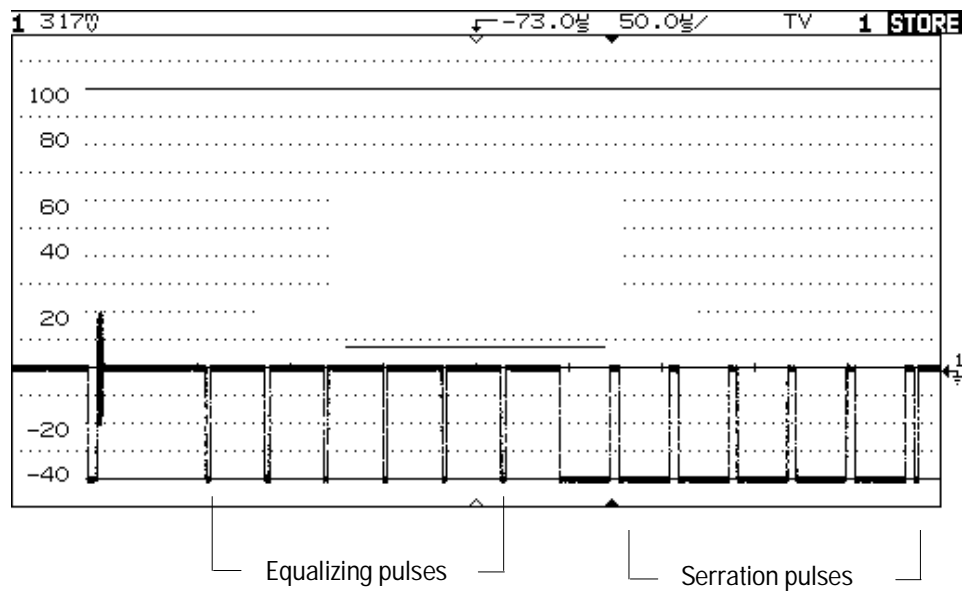

Triggering on Field 1

To trigger on all fields of the video signal

To quickly and easily view transitions between fields, or to find the amplitude differences between the fields, use the All Fields trigger. The oscilloscope will trigger on the first field it finds at the start of acquisition.

- 1 Select the TV display, TV as the trigger mode, and the appropriate TV standard as described in the section, "To autoscale on a video signal."
- 2 Press **Slope/Coupling** in the TRIGGER section of the front panel, then press the **Mode** softkey until **All Fields** appears.

Figure 3-4

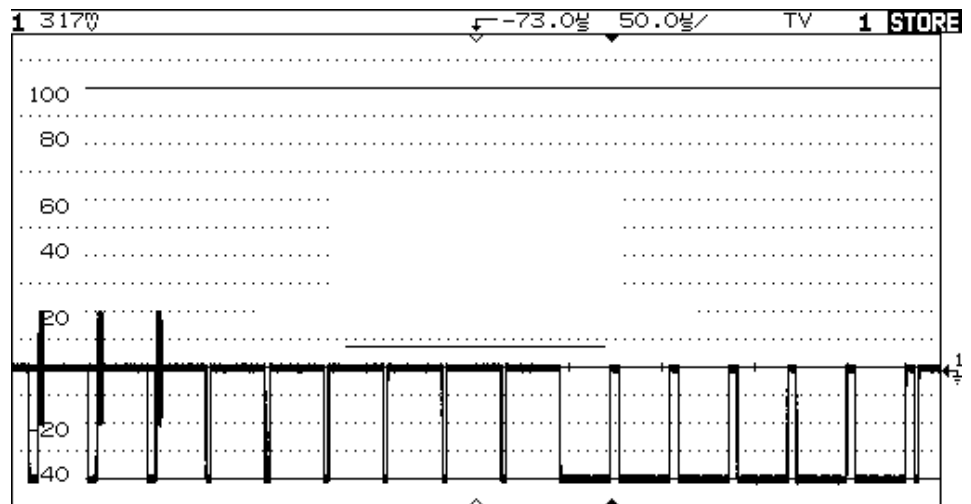

Triggering on All Fields

To trigger on odd or even fields

To check the envelope of your video signals, or to measure worst case distortion, trigger on the odd or even fields. When Field 1 is selected, the oscilloscope triggers on color fields 1 or 3. When Field 2 is selected, the oscilloscope triggers on color fields 2 or 4.

- 1 Select the TV display, TV as the trigger mode, and the appropriate TV standard as described in the section, "To autoscale on a video signal."
- 2 Press **Slope/Coupling** in the TRIGGER section of the front panel, then press the Mode softkey until Field 1 or Field 2 appears.

The trigger circuits look for the position of the start of Vertical Sync to determine the field. But this definition of field does not take into consideration the phase of the reference subcarrier. When Field 1 is selected, the trigger system will find any field where the vertical sync starts on Line 4. In the case of NTSC video, the oscilloscope will trigger on color field 1 alternating with color field 3 (see the following figure). This setup can be used to measure the envelope of the reference burst.

Figure 3-5

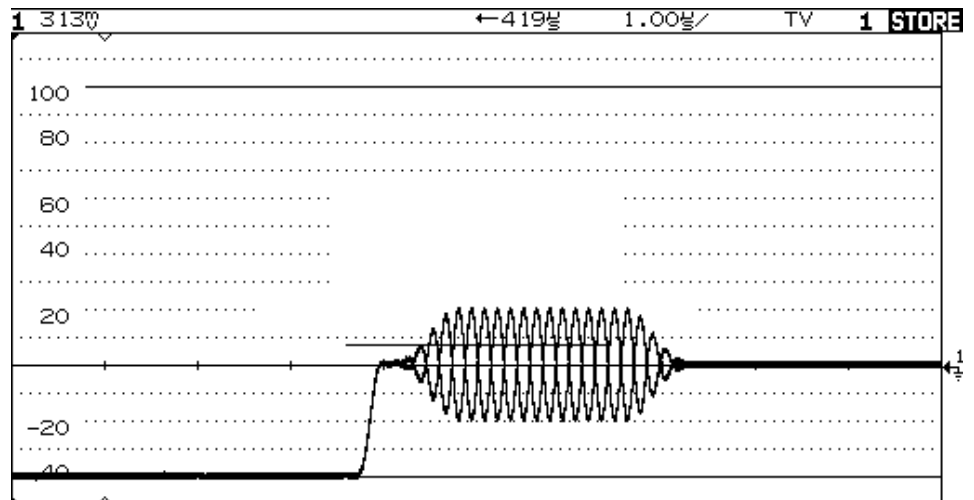

Triggering on Color Field 1 Alternating with Color Field 3

If a more detailed analysis is required, then only one color field should be selected to be the trigger. You can do this by using the oscilloscope's holdoff control. Using the holdoff settings shown in the following table, the oscilloscope will now trigger on color field 1 OR color field 3 when Field 1 is selected. This is known as odd field selection. Even fields will be selected with Field 2.

Table 3-2

Holdoff Settings		
Video Standard	Fields/Picture	Holdoff Range
NTSC	4	33.5 ms to 50.0 ms
PAL	8	80.7 ms to 120 ms
SECAM	4	40.4 ms to 60 ms
PAL-M	8	80.4 ms to 120 ms

The holdoff can be more easily set if the sweep speed is set to 5 ms/div. Once you have established your desired holdoff time, return to the desired time base setting. The holdoff setting will remain unchanged.

Figure 3-6

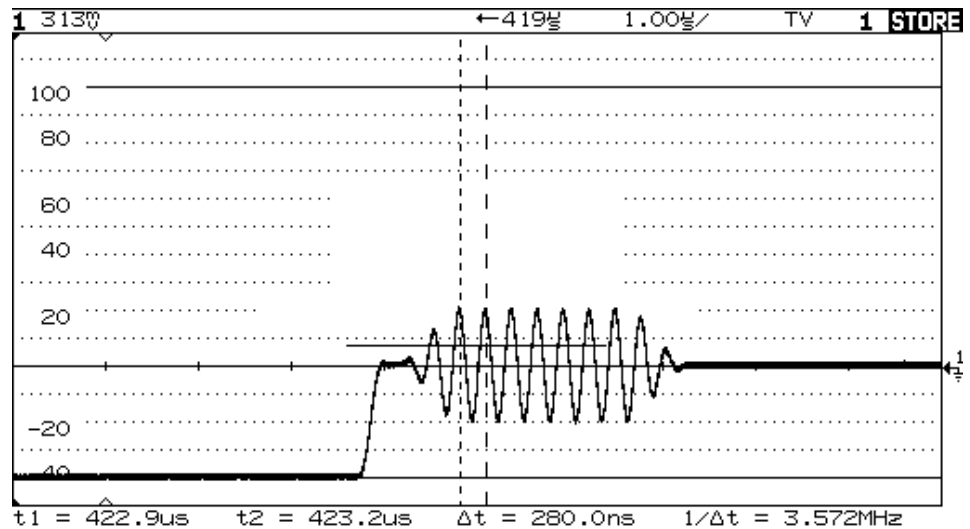

Triggering on Color Field 1 using Holdoff

To make cursor measurements

The following steps guide you through the front-panel Cursors key. You can use the cursors to make custom voltage or time measurements on the signal. Examples of custom measurements include rise time measurements from reference levels other than 10-90%, frequency and width measurements from levels other than 50%, channel-to-channel delay measurements, and voltage measurements. With Option 005 in your oscilloscope, the cursors can also be calibrated in IRE units.

- 1 Connect a video signal to the oscilloscope and obtain a stable display.
- 2 Press **Display** , then press the **Grid** softkey to select **TV**.
- 3 Press **Mode** , then press the **Video Autoscale** softkey.
- 4 Press **Cursors** .

A softkey menu appears with six softkey choices. Four of the softkeys are cursor functions.

Source Selects a channel for the voltage cursor measurements. The cursor is calibrated to the Volts/div of the selected channel.

Active Cursor There are four cursor choices: **V1** and **V2** are voltage cursors, **t1** and **t2** are time cursors. Use the knob below the **Cursors** key to move the cursors. To move the cursors together, press the **V1** and **V2** softkeys simultaneously or press the **t1** and **t2** softkeys simultaneously.

Clear Cursors Erases the cursor readings and removes the cursors from the display.

TV graticule

With the TV graticule ON, the voltage cursors are calibrated in IRE units.
With the TV graticule OFF, the voltage cursors are calibrated in volts.
IRE units only make sense if the video signal is scaled properly, such as after a video autoscale.

Figure 3-7

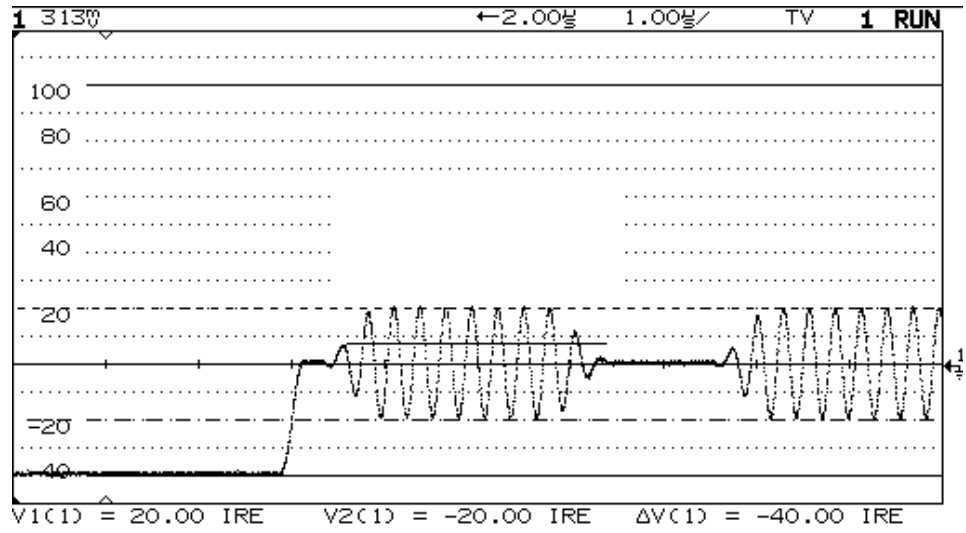

Color Sync measured with the cursors as 40 IRE

To use delayed sweep

Delayed sweep is a magnified portion of the main sweep. You can use delayed sweep to locate and horizontally expand part of the main sweep for a more detailed (high resolution) analysis of signals, for example multi-burst frequencies. The following steps show you how to use delayed sweep. Notice that the steps are very similar to operating the delayed sweep in analog oscilloscopes.

- 1 Connect a signal to the oscilloscope and obtain a stable display.
- 2 Press **Main/Delayed** .
- 3 Press the **Delayed** softkey.

The screen divides in half. The top half displays the main sweep, and the bottom half displays an expanded portion of the main sweep. This expanded portion of the main sweep is called the delayed sweep. The top half also has two solid vertical lines called markers. These markers show what portion of the main sweep is expanded in the lower half. The size and position of the delayed sweep are controlled by the Time/Div and Delay knobs. The Time/Div next to the  symbol is the delayed sweep sec/div. The delay value is displayed for a short time at the bottom of the display.

- To display the delay value of the delayed time base, either press **Main/Delayed** or turn the Delay knob.
- To change the main sweep Time/Div, you must turn off the delayed sweep.

Since both the main and delayed sweeps are displayed, there are half as many vertical divisions so the vertical scaling is doubled. Notice the changes in the status line.

- To display the delay time of the delayed sweep, either press **Main/Delayed** or turn the delay knob. The delay value is displayed near the bottom of the screen.

If the TV graticule is selected, notice that it is presented in both main and delayed sweeps. For more information on delayed sweep operation, see "To use delayed sweep" in chapter 2.

Automatic measurements are controlled by the delayed sweep shown in the following two figures.

Figure 3-8

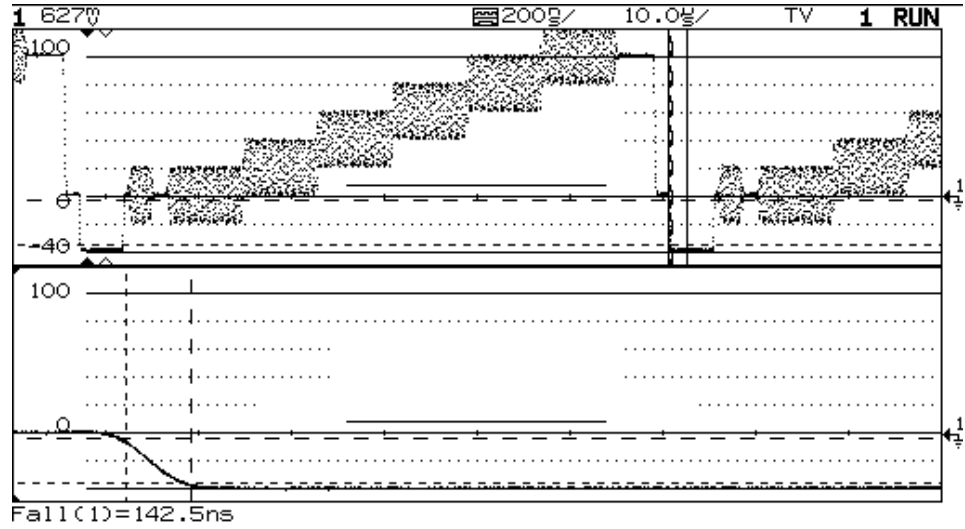

Modulated staircase or 5-step, measuring sync pulse fall time with delayed sweep

Figure 3-9

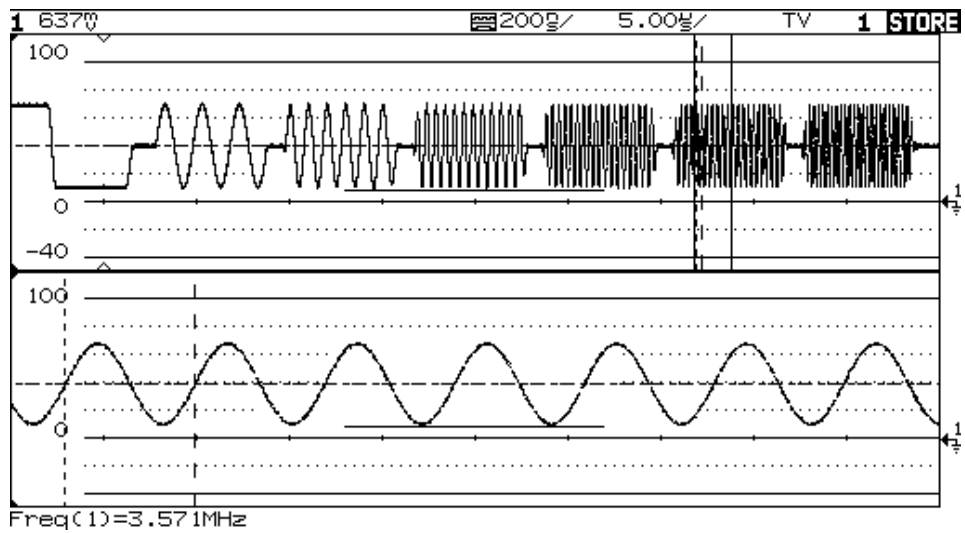

Windowed frequency measurement in a multi-burst by use of delayed sweep

To analyze video waveforms with Option 005

The combination of the TV trigger, delayed sweep, and automatic measurements allow this oscilloscope to precisely analyze video waveforms. There is no need for external clamping to obtain a stable trigger when you are viewing unclamped video signals. This is because the TV sync separator in the oscilloscope has an internal clamp circuit in the trigger path. Because there is no clamp in the vertical path of your oscilloscope, you will be able to observe any DC level shifts in the video on the oscilloscope display. To eliminate this position shifting as the DC component of the video changes, select AC coupling.

For this exercise, we connect the oscilloscope to the video output terminals on a television. We set up the oscilloscope to view the second vertical interval with delayed sweep windowed on the vertical interval test signals (VITS). Then we make windowed measurements with the delayed sweep.

- 1** Connect a TV signal to channel 1, and select channel 1 as your trigger source.
- 2** Press **Slope/Coupling** in the TRIGGER section of the front panel, then press the TV softkey.
- 3** Select the desired TV Standard, such as NTSC, PAL, PAL-M or SECAM.
- 4** Press **Mode** , then press the Video Autoscale softkey.

- 5 Set the time base to $200\ \mu\text{s}/\text{div}$, then center the signal on the display with the delay knob (delay about $800\ \mu\text{s}$).
- 6 Press **Main/Delayed** , then press the **Delayed** softkey.
- 7 Set the delayed sweep to $20\ \mu\text{s}/\text{div}$, then set the expanded portion over the VITS (delay about $988.8\ \mu\text{s}$).

Figure 3-10

This figure shows the second vertical interval test signals displayed with delayed sweep.

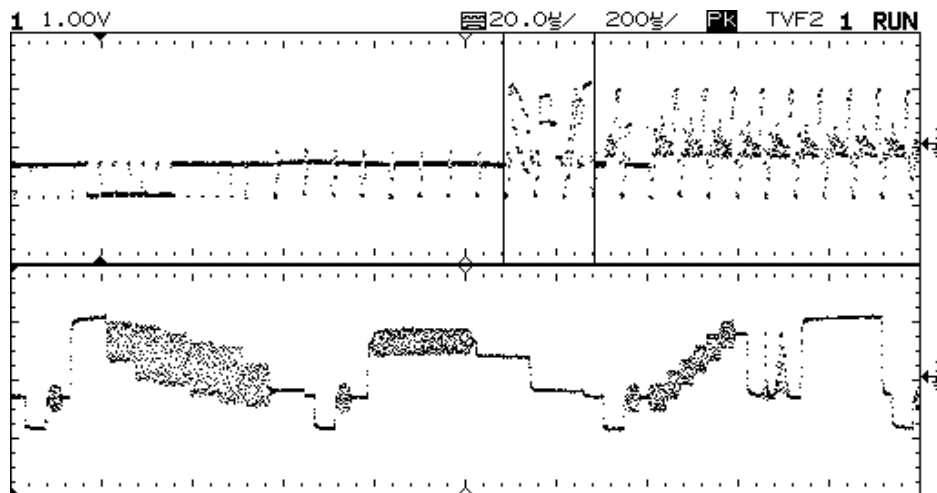

Second VITS Displayed

To window in on harmonic distortion using FFT

Sine waves that are not perfectly shaped in the time domain generate harmonics in the frequency domain. Viewing this distortion in the time domain is usually very difficult, unless the waveform is severely distorted. However, in the frequency domain, these harmonics are very apparent. Your oscilloscope, when used with the HP 54657A, HP 54658A, or HP 54659B Measurement/Storage module, have the ability to perform frequency domain analysis on a time domain waveform using the Fast Fourier Transform (FFT). A special case of measuring the harmonic distortion in a sine wave is found in video applications. The 3.58 MHz color-subcarrier frequency embedded in an NTSC composite video signal has some amount of harmonic distortion associated with the subcarrier frequency. To measure just this signal, the scope's time/division and delay controls are used to zoom in on the color burst in the time domain.

Figure 3-11

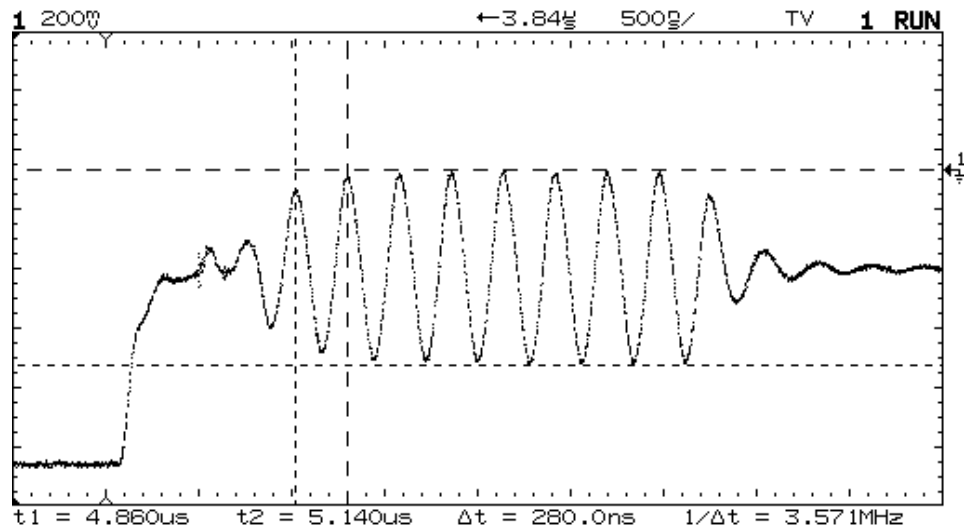

The scope controls are used to zoom in on the color burst in the time domain

The FFT function then shows the harmonic content of the subcarrier in the figure below. Had the time/division and delays controls not been used to zoom in on the desired subcarrier, the entire video signal (with many frequency components) would have appeared in the frequency domain display. These frequency components would have obscured the color subcarrier and its harmonics. This example illustrates a general technique of using the time domain controls of the scope to select specific time intervals for FFT analysis.

Figure 3-12

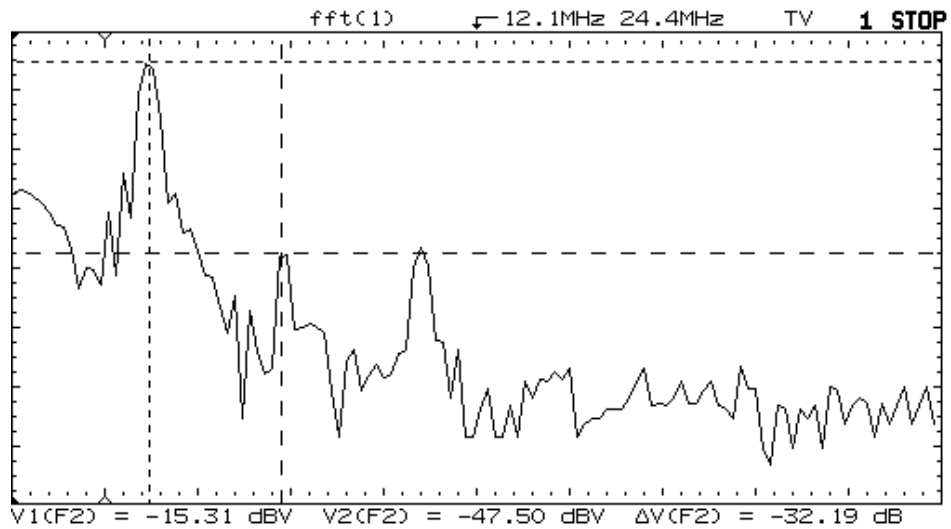

The FFT function shows that the harmonic content of the color burst is more than 31 dB below the subcarrier

To connect to other instruments

The rear panel outputs provide an easy way to connect your Option 005-equipped oscilloscope to other instruments such as spectrum analyzers or frequency counters. To use a frequency counter:

- 1** Connect the vertical output of the oscilloscope to the counter's input.
- 2** Connect the frequency to be measured to channel 1.
- 3** Press **Autoscale** , then select the trigger source to be channel 1. Adjust the counter as required.

The amplitude of the vertical output signal is proportional to the amplitude as displayed on the oscilloscope.

The trigger source selection is the control that determines which channel's signal is present at the vertical output (VERT OUT) connector on the rear of the oscilloscope.

4

Verifying Oscilloscope Performance 4-5
Adjusting the Oscilloscope 4-27
Troubleshooting the Oscilloscope 4-40
Replacing Parts in the Oscilloscope 4-49

Service

Service

If the oscilloscope is under warranty, you must return it to Hewlett-Packard for all service work covered by the warranty. See "To return the oscilloscope to Hewlett-Packard," on page 4-4. If the warranty period has expired, you can still return the oscilloscope to Hewlett-Packard for all service work. Contact your nearest Hewlett-Packard Sales Office for additional details on service work.

If the warranty period has expired and you decide to service the oscilloscope yourself, the instructions in this chapter can help you keep the oscilloscope operating at optimum performance.

This chapter is divided into the following four sections:

- Verifying Oscilloscope Performance on page 4-5
- Adjusting the Oscilloscope on page 4-27
- Troubleshooting the Oscilloscope on page 4-40
- Replacing Parts in the Oscilloscope on page 4-49

Service should be performed by trained service personnel only. Some knowledge of the operating controls is helpful, and you may find it helpful to read chapter 1, "The Oscilloscope at a Glance."

Table 4-1

Recommended list of test equipment to service the oscilloscope

Equipment	Critical specifications	Recommended Model/Part	Use
Constant amplitude signal generator	100 MHz, Constant amplitude $\pm 1\%$ (250 MHz for HP 54602)	Tek SG503 Tek TM501	P
Digital multimeter	0.1 mV resolution, better than 0.01% accuracy	HP 34401A	P, A, T
Oscilloscope	100 MHz	HP 54600B or equivalent	T
Power supply	14 mV to 35 Vdc, 0.1 mV resolution	HP 6114A	P
Probe	10:1 division ratio	HP 10432A	T
Pulse generator	Rise time < 875 ps	PSPL 1107B TD and PSPL 1110B Driver	A
Pulse generator	10 kHz, 500 mV p-p, rise time < 5 ns	HP 8112A	A
Time marker generator	Stability 5 ppm after 1/2 hour	TG 501A and TM 503A	P
Feedthrough	50 Ω , BNC (m) and (f)	HP 10100C	P, A
Power splitter	Outputs differ < 0.15 dB	HP 11667B	P
Shorting cap	BNC	HP 1250-0774	P
Adapter	SMA (f) to BNC (m)	HP 1250-1787	A
Adapter	BNC (f-f)	HP 1250-0080	A
Adapter	BNC tee (m) (f) (f)	HP 1250-0781	A
Adapter	N (m) to BNC (f), Qty 3	HP 1250-0780	P
Adapter	BNC (f) to dual banana (m)	HP 1251-2277	P
Cable	BNC, Qty 3	HP 10503A	P, A
Cable	BNC, 9 inches, Qty 2	HP 10502A	A

Additional equipment needed if you perform the alternate bandwidth test when verifying oscilloscope performance.

Signal generator	1 to 100 MHz at 200 mV (250 MHz for HP 54602B)	HP 8656B opt 001	P
Power meter and Power Sensor	1 to 100 MHz $\pm 3\%$ accuracy (250 MHz for HP 54602B)	HP 436A and HP 8482A	P
Cable	Type N (m) 24 inch	HP 11500B	P
Adapter	Type N (m) to BNC (m)	HP 1251-0082	P

To return the oscilloscope to Hewlett-Packard

Before shipping the oscilloscope to Hewlett-Packard, contact your nearest Hewlett-Packard Sales Office for additional details.

1 Write the following information on a tag and attach it to the oscilloscope.

- Name and address of owner
- Model number
- Serial number
- Description of service required or failure indications

2 Remove all accessories from the oscilloscope.

The accessories include the power cord, probes, cables, and any modules attached to the rear of the oscilloscope. Do not ship accessories back to Hewlett-Packard unless they are associated with the failure symptoms.

3 Protect the control panel with cardboard.

4 Pack the oscilloscope in styrofoam or other shock-absorbing material and place it in a strong shipping container.

You can use either the original shipping containers, or order materials from an HP Sales Office. Otherwise, pack the oscilloscope in 3 to 4 inches of shock-absorbing material to prevent movement inside the shipping container.

5 Seal the shipping container securely.

6 Mark the shipping container as FRAGILE.

Verifying Oscilloscope Performance

This section shows you how to verify the electrical performance of the oscilloscope, using the performance characteristics in chapter 5 as the standard. The characteristics checked are dc calibrator, voltage measurement accuracy, bandwidth, horizontal accuracy, and trigger sensitivity.

You should verify the performance of the oscilloscope when you first receive it, and every 12 months or after 2,000 hours of operation. Also, make sure you allow the oscilloscope to operate for at least 30 minutes before you begin the following procedures.

Perform self-calibration first

For the oscilloscope to meet all of the verifications tests in the ambient temperature where it will be used, the self-calibration tests described on page 4-31 should first be performed. Allow the unit to operate for at least 30 minutes before performing the self-calibration.

Each procedure lists the recommended equipment for the test. You can use any equipment that meets the critical specifications. However, the procedures are based on the recommended model or part number.

Starting on page 4-23 is a series of test records (one for each model of oscilloscope) for recording the test results of each procedure. Use the test results to gauge the performance of the oscilloscope over time.

To check the output of the DC CALIBRATOR

In this test you measure the output of the DC CALIBRATOR with a multimeter. The DC CALIBRATOR is used for self-calibration of the oscilloscope. The accuracy is not specified, but it must be within the test limits to provide for accurate self-calibration.

Test limits 5.000 V \pm 10 mV and 0.000 V \pm 500 μ V.

Table 4-2

Equipment Required

Equipment	Critical specifications	Recommended Model/Part
Digital Multimeter	0.1 mV resolution, better than 0.01% accuracy	HP 34401A
Cable	BNC	HP 10503A

- 1 Connect a multimeter to the rear panel DC CALIBRATOR connector.
- 2 Press **Print/Utility**.
- 3 Press the **Self Test** softkey, then press the **DAC** softkey.

The multimeter should measure 0.00 V dc \pm 500 μ V. If the result is not within the test limits, see "Troubleshooting the oscilloscope," on page 4-40.

- 4 Press any key to continue the test.

The multimeter should read 5.000 V \pm 10 mV. If the result is not within the test limits, see "Troubleshooting the oscilloscope," on page 4-40.

To verify voltage measurement accuracy

In this test you verify the voltage measurement accuracy by measuring the output of a power supply using dual cursors on the oscilloscope, and comparing the results with a multimeter.

Test limits $\pm 1.9\%$ of full scale (HP 54600B, HP 54601B, HP 54602B)
 $\pm 2.4\%$ of full scale (HP 54603B)

Table 4-3

Equipment Required

Equipment	Critical specifications	Recommended Model/Part
Power supply	14 mV to 35 Vdc, 0.1 mV resolution	HP 6114A
Digital multimeter	Better than 0.1% accuracy	HP 34401A
Cable	BNC, Qty 2	HP 10503A
Shorting cap	BNC	HP 1250-0774
Adapter	BNC (f) to banana (m)	HP 1251-2277
Adapter	BNC tee (m) (f) (f)	HP 1250-0781

Service
Verifying Oscilloscope Performance

- 1** Set up the oscilloscope.
 - a** Press **Setup** , then press the **Default Setup** softkey.
 - b** Press **Voltage** , then press the **V avg** softkey.
 - c** Set the Volts/Div to the first line of table 4-4.
 - d** Adjust the channel 1 Position knob to place the baseline near (but not at) the bottom of the display.
- 2** Press **Cursors** , then press the **V1** softkey.
- 3** Using the cursors knob, set the **V1** cursor on the baseline.

If you are in an electrically noisy environment, it can help to place a shorting cap on the input BNC connector when positioning V1.
- 4** Connect the power supply to the oscilloscope and to the multimeter, using the BNC tee and cables.
- 5** Set the power supply output to the first line in table 4-4.

6 Press the V2 softkey, then position the V2 cursor to the baseline.

The ΔV value at the bottom of the display should be within the test limits of table 4-4. If a result is not within the test limits, see "Troubleshooting the Oscilloscope," on page 4-40.

7 Continue checking the voltage measurement accuracy with the remaining lines in table 4-4.

**Table 4-4
Voltage Measurement Accuracy**

Volts/Div setting	Power supply setting	Test limits		
		HP 54600B, HP 54601B	HP 54602	HP 54603B
5 V/Div	35 V	34.24 V to 35.76 V	34.24 V to 35.76 V	34.04 V to 35.96 V
2 V/Div	14 V	13.70 V to 14.30 V	13.70 V to 14.30 V	13.62 V to 14.38 V
1 V/Div	7 V	6.848 V to 7.152 V	6.848 V to 7.152 V	6.808 V to 7.192 V
0.5 V/Div	3.5 V	3.424 V to 3.576 V	3.424 V to 3.576 V	3.404 V to 3.596 V
0.2 V/Div	1.4 V	1.370 V to 1.430 V	1.370 V to 1.430 V	1.362 V to 1.438 V
0.1 V/Div	700 mV	684.8 mV to 715.2 mV	684.8 mV to 715.2 mV	680.8 mV to 719.2 mV
50 mV/Div	350 mV	342.4 mV to 357.6 mV	342.4 mV to 357.6 mV	340.4 mV to 359.6 mV
20 mV/Div	140 mV	137.0 mV to 143.0 mV	137.0 mV to 143.0 mV	136.2 mV to 143.8 mV
10 mV/Div	70 mV	68.48 mV to 71.52 mV	68.48 mV to 71.52 mV	68.08 mV to 71.92 mV
5 mV/Div*	35 mV	34.48 mV to 36.52 mV	34.24 mV to 35.76 mV	33.08 mV to 36.92 mV
2 mV/Div*	14 mV	12.48 mV to 15.52 mV	13.70 mV to 14.30 mV	12.08 mV to 15.92 mV
1 mV/Div**	7 mV	—	6.696 mV to 7.304 mV	—

* Full scale is defined as 80 mV for the 5 mV/div and 2 mV/div ranges on HP 54600B, HP 54601B, HP 54603B.
 ** 1 mV/div range only on HP 54602B. Full scale is defined as 16 mV .

8 Disconnect the power supply from the oscilloscope, then repeat steps 1 to 7 for channel 2 (channels 2 to 4 on the HP 54601B and HP 54602B). On the HP 54601B and HP 54602B, channels 3 and 4, check the 0.5 V/div and 0.1 V/div range only.

To verify bandwidth

In this test you verify the bandwidth of the oscilloscope by using a constant amplitude signal generator. The frequency of the signal generator is set to 250 kHz to establish a reference level. Then, the frequency is changed to the upper bandwidth limit and the level is checked to see if it is 3 dB from the reference level.

The following procedure is a simple method to check bandwidth. However, there is a possibility of measurement uncertainty with a constant amplitude signal generator. If you need a more exact procedure for checking bandwidth see, "To verify the bandwidth (alternate method)" on page 4-12.

Test limits

HP 54600B and HP 54601B, all channels (-3 dB)
dc to 100 MHz
ac coupled 10 Hz to 100 MHz.

HP 54602B
Channels 1 & 2 (-3 dB)
10 mV/div to 5 V/div
dc to 150 MHz
1 mV/div to 5 mV/div
dc to 100 MHz
ac coupled 10 Hz to upper limit of vertical range
Channels 3 & 4 (-3 dB)
dc to 250 MHz.

HP 54603B, all channels (-3 dB)
dc to 60 MHz
ac coupled 10 Hz to 60 MHz.

Table 4-5

Equipment Required

Equipment	Critical specifications	Recommended Model/Part
Constant amplitude signal generator	100 MHz, Constant amplitude $\pm 1\%$ (250 MHz for HP 54602B)	Tek SG503/Tek TM501
Cable	BNC	HP 10503A
Feedthrough	50 Ω , BNC (m) and (f)	HP 10100C

- 1 Using the 50-Ω feedthrough and the BNC cable, connect the signal generator to channel 1 of the oscilloscope.
- 2 Set the frequency of the signal generator to 250 kHz and the amplitude to about 800 mV.
- 3 Press **Autoscale** .
- 4 Adjust the output of the signal generator for exactly 8 divisions of vertical deflection.
- 5 Change the frequency of the signal generator to the value shown below for your instrument.

Table 4-6

Signal Generator Frequency Setting				
Selected Channel	HP 54600B	HP 54601B	HP 54602B *	HP 54603B
Channel 1	100 MHz	100 MHz	150 MHz	60 MHz
Channel 2	100 MHz	100 MHz	150 MHz	60 MHz
Channel 3	—	100 MHz	250 MHz	—
Channel 4	—	100 MHz	250 MHz	—

*1mv/div to 5 mv/div dc = 100 MHz.

- 6 Change the sweep speed of the oscilloscope to 5 ns/div and observe the display.
The vertical amplitude of the signal on the display should be equal to or greater than 5.66 divisions (−3 dB point). If the result is not ≤−3 dB, see "Troubleshooting the Oscilloscope," on page 4-40.
- 7 Repeat steps 1 through 6 for channel 2 (channels 2 to 4 on the HP 54601B and HP 54602B).

To verify bandwidth (alternate method)

In this test you verify the bandwidth of the oscilloscope by using a power meter and power sensor to set the output of a signal generator at 1 MHz and the upper bandwidth limit. You use the peak-to-peak voltage at 1 MHz and the upper bandwidth limit to calculate the bandwidth response of the oscilloscope.

Test limits

HP 54600B and HP 54601B, all channels (-3 dB)
dc to 100 MHz
ac coupled 10 Hz to 100 MHz.

HP 54602B
Channels 1 & 2 (-3 dB) *
dc to 150 MHz
ac coupled 10 Hz to 150 MHz.
Channels 3 & 4 (-3 dB)
dc to 250 MHz.

HP 54603B, all channels (-3 dB)
dc to 60 MHz
ac coupled 10 Hz to 60 MHz.

Table 4-7

Equipment Required

Equipment	Critical specifications	Recommended Model/Part
Signal generator	1 to 100 MHz at 200 mV (250 MHz for HP 54602B)	HP 8656B opt 001
Power meter and Power Sensor	1 to 100 MHz $\pm 3\%$ accuracy (250 MHz for HP 54602B)	HP 436A and HP 8482A
Power splitter	Outputs differ by <0.15 dB	HP 11667B
Cable	Type N (m), 24 inch	HP 11500B
Adapter	Type N (m) to BNC (m)	HP 1251-0082
Feedthrough	50 Ω , BNC (m) and (f)	HP 10100C

*1mv/div to 5 mv/div dc = 100 MHz.

- 1** Connect the equipment.
 - a** Connect the signal generator to the input of the power splitter.
 - b** Connect the power sensor to one output of the power splitter, and connect channel 1 of the oscilloscope to the other power splitter output (put the 50 Ω feedthrough at the input of the oscilloscope).
- 2** Set up the oscilloscope.
 - a** Press **Setup** , then press the **Default Setup** softkey.
 - b** Set the time base to 500 ns/div.
 - c** Set channel 1 to 100 mV/div.
 - d** Press **Display** , then press the **Average** softkey.
 - e** Toggle the # **Average** softkey to select **8** averages.
- 3** Set the signal generator for 1 MHz at about 5.6 dBm.

Notice that the signal on the display is about 5 cycles and six divisions of amplitude.

Service
Verifying Oscilloscope Performance

- 4 Press **Voltage** , then press the **Vp-p** softkey.

Wait a few seconds for the measurement to settle (averaging is complete), then note the Vp-p reading from the bottom of the display.

Vp-p = _____ mV.

- 5 Set the calibration factor percent of the power meter to the 1 MHz value from the calibration chart on the probe, then press dB (REF) on the power meter to set a 0 dB reference.
- 6 Change the frequency of the signal generator to the value shown below for your instrument.

Table 4-8

Signal Generator Frequency Setting

Selected Channel	HP 54600B	HP 54601B	HP 54602B *	HP 54603B
Channel 1	100 MHz	100 MHz	150 MHz	60 MHz
Channel 2	100 MHz	100 MHz	150 MHz	60 MHz
Channel 3	—	100 MHz	250 MHz	—
Channel 4	—	100 MHz	250 MHz	—

*1mv/div to 5 mv/div = 100 MHz.

- 7 Set the calibration factor of the power meter to 100 MHz percent value from the chart on the probe.

Adjust the amplitude of the signal generator for a power reading as close as possible to 0.0 dB (REL). Power meter reading = _____ dB.

8 Change the time base to 5 ns/div.

Wait a few seconds for the measurement to settle (averaging is complete), then note the V_{p-p} reading from the bottom of the display.

$V_{p-p} = \text{_____ mV}$.

9 Calculate the response using the following formula.

$$20 \log_{10} \left(\frac{\text{step 8 result}}{\text{step 4 result}} \right)$$

10 Correct the result from step 9 with any difference in the power meter reading from step 7. Make sure you observe all number signs.

For example

Result from step 9 = -2.3 dB

Power meter reading from step 7 = -0.2 dB (REL)

True response = (-2.3) - (-0.2) = -2.1 dB

The true response should be $\leq \pm 3$ dB.

If the result is not $\leq \pm 3$ dB, see "Troubleshooting the Oscilloscope," on page 4-40.

11 Repeat steps 1 to 10 for channel 2 (channels 2 to 4 on the HP 54601B and HP 54602B).

When you measure the bandwidth on channels 3 and 4, use the 0.1 V/Div range.

To verify horizontal Δt and $1/\Delta t$ accuracy

In this test you verify the horizontal Δt and $1/\Delta t$ accuracy by measuring the output of a time mark generator with the oscilloscope.

Test limits $\pm 0.01\%$ $\pm 0.2\%$ of full scale ± 200 ps.

Table 4-9

Equipment Required

Equipment	Critical specifications	Recommended Model/Part
Time marker generator	Stability 5 ppm after 1/2 hour	TG 501A and TM 503A
Cable	BNC	HP 10503A
Termination	50 Ω , BNC connectors (m) (f)	HP 10100C

- 1 Connect the time mark generator to channel 1 using the feedthrough at the oscilloscope input. Then, set the time mark generator for 0.1 ms markers.
- 2 Setup the oscilloscope.
 - a Press **Setup**, then press the **Default Setup** softkey.
 - b Press **Display**, then press the **Vectors Off** softkey.
 - c Press **Autoscale**.
 - d Set the time base to 20 $\mu\text{s}/\text{div}$.
 - e Adjust the trigger level to obtain a stable display.

- 3** Press **Time** , then press the **Freq** and **Period** softkeys.

You should measure the following:

Frequency 10 kHz, test limits are 9.959 kHz to 10.04 kHz.

Period 100 μ s, test limits are 99.59 μ s to 100.4 μ s.

If the measurements are not within the test limits, see "Troubleshooting the Oscilloscope," on page 4-40.

- 4** Change the time mark generator to 1 μ s, and change the time base to 200 ns/div. Adjust the trigger level to obtain a stable display.

- 5** Press **Time** , then press the **Freq** and **Period** softkeys.

You should measure the following:

Frequency 1 MHz, test limits are 995.7 kHz to 1.004 MHz.

Period 1 μ s, test limits are 995.7 ns to 1.004 μ s.

If the measurements are not within the test limits, see "Troubleshooting the Oscilloscope," on page 4-40.

HP 54600B,
HP 54601B,
HP 54602B only

- 6** Change the time mark generator to 10 ns, and change the time base to 5 ns/div. Adjust the trigger level to obtain a stable display.

- 7** Press **Time** , then press the **Freq** and **Period** softkeys.

You should measure the following:

Frequency 100 MHz, test limits are 97.08 MHz to 103.1 MHz.

Period 10 ns, test limits are 9.699 ns to 10.30 ns.

If the measurements are not within the test limits, see "Troubleshooting the Oscilloscope," on page 4-40.

HP 54603B only

- 8** Change the time mark generator to 20 ns, and change the time base to 5 ns/div. Adjust the trigger level to obtain a stable display.

- 9** Press **Time** , then press the **Freq** and **Period** softkeys.

You should measure the following:

Frequency 50 MHz, test limits are 49.25 MHz to 50.77 MHz.

Period 20 ns, test limits are 19.70 ns to 20.30 ns.

If the measurements are not within the test limits, see "Troubleshooting the Oscilloscope," on page 4-40.

To verify trigger sensitivity

In this test you verify the trigger sensitivity by applying 25 MHz to the oscilloscope. The amplitude of the signal is decreased to the specified levels, then you check to see if the oscilloscope is still triggered. You then repeat the process at the upper bandwidth limit.

Test limits

Internal trigger

HP 54600B and HP 54601B, all channels

dc to 25 MHz, 0.35 div or 3.5 mV p-p

dc to 100 MHz, 1 div or 10 mV p-p

HP 54602B

Channels 1 & 2

>5 mV/div

dc to 25 MHz, 0.35 div or 3.5 mV p-p

dc to 150 MHz, 1 div or 10 mV p-p

1 mV to 5 mV/div

dc to 25 MHz, 1 div or 2 mV

dc to 100 MHz, 1.5 div or 3 mV

Channels 3 & 4

dc to 25 MHz, 0.35 div or 3.5 mV p-p

dc to 250 MHz, 1 div or 100 mV p-p

HP 54603B, all channels

dc to 25 MHz, 0.35 div or 3.5 mV p-p

dc to 60 MHz, 1 div or 10 mV p-p

External trigger

HP 54600B and HP 54603B only

dc to 25 MHz, 50 mV p-p

dc to 100 MHz, 100 mV p-p (HP 54600B)

dc to 60 MHz, 100 mV p-p (HP 54603B)

Table 4-10

Equipment Required		
Equipment	Critical specifications	Recommended Model/Part
Signal generator	sine waves: 25 MHz and 100 MHz–HP 54600B/HP 54601B 25 MHz and 250 MHz–HP 54602B 25 MHz and 60 MHz–HP 54603B	Tek SG 503/Tek TM 501
Power splitter (HP 54600B/03B only)	Outputs differ <0.15 dB	HP 11667B
Cable	BNC, Qty 3	HP 10503A
Adapter	N (m) to BNC (f), Qty 3	HP 1250-0780
Feedthrough	50 Ω, BNC (m) and (f)	HP 10100C

**Internal Trig
Sensitivity**

- 1 Press **Setup** , then press the **Default Setup** softkey.
- 2 Connect the signal generator to channel 1.
- 3 Verify the trigger sensitivity at 25 MHz and 0.35 divisions.
 - a Set the signal generator to 25 MHz and about 50 mV.
 - b Press **Autoscale** .
 - c Decrease the output of the signal generator until there is 0.35 vertical divisions of the signal displayed.

The trigger should be stable. If the triggering is not stable, try adjusting the trigger level. If adjusting the trigger level makes the triggering stable, the test still passes. If adjusting the trigger does not help, see "Troubleshooting the Oscilloscope," on page 4–40.
- 4 Verify the trigger sensitivity at 1 division for the frequencies shown below.
 - a Change the output of the signal generator to the frequency shown below for your instrument and set amplitude to about 100 mV.

Service
Verifying Oscilloscope Performance

Table 4-11

Signal Generator Frequency Setting				
Selected Channel	HP 54600B	HP 54601B	HP 54602B *	HP 54600B
Channel 1	100 MHz	100 MHz	150 MHz	60 MHz
Channel 2	100 MHz	100 MHz	150 MHz	60 MHz
Channel 3	—	100 MHz	250 MHz	—
Channel 4	—	100 MHz	250 MHz	—

*1mv/div to 5 mv/div = 100 MHz.

- b Press **Autoscale** .
- c Decrease the output of the signal generator until there is 1 vertical division of the signal displayed.

The trigger should be stable. If the triggering is not stable, try adjusting the trigger level. If adjusting the trigger level makes the triggering stable, the test still passes. If adjusting the trigger does not help, see "Troubleshooting the Oscilloscope," on page 4-40.
- 5 Repeat steps 1 through 4 for channel 2 on the HP 54600B and HP 54603B (channels 2 to 4 on the HP 54601B and HP 54602B).

**External Trig
Sensitivity**

- 6** Verify the external trigger sensitivity at 100 MHz (60 MHz for HP 54603B) and 100 mV p-p (HP 54600B and HP 54603B only).
 - a** Press **Source** , then press the **Ext** softkey.
 - b** Use the power splitter to connect the signal generator to the channel 1 input and to the external trigger input.
 - c** Change the output of the signal generator to 100 MHz and 200 mV p-p.

The power splitter divides the 200 mV so that 100 mV is applied to each of the oscilloscope inputs.

The oscilloscope triggering should be stable. If the triggering is not stable, try adjusting the trigger level. If adjusting the trigger level makes the triggering stable, the test still passes. If adjusting the trigger does not help, see "Troubleshooting the Oscilloscope," on page 4–40.
- 7** Verify the external trigger sensitivity at 25 MHz and 50 mV p-p (HP 54600B and HP 54603B only).
 - a** Change the output of the signal generator to 25 MHz at about 100 mV.
 - b** Press **Autoscale** .

The oscilloscope triggering should be stable. If the triggering is not stable, try adjusting the trigger level. If adjusting the trigger level makes the triggering stable, the test still passes. If adjusting the trigger does not help, see "Troubleshooting the Oscilloscope," on page 4–40.

To verify Vertical Output on Option 005

This section applies only to Option 005 Enhanced TV/Video Trigger if installed on the HP 54602B.

In this test we will use the oscilloscope's channel 2 to measure the amplitude of the Vertical Output (VERT OUT connector on rear panel) signal.

Test limits: ~90 mVp-p into 50Ω with a full screen input.

Table 4-8

Equipment Required

Equipment	Critical specifications	Recommended Model/Part
Signal generator	1 to 500 MHz at 200 mV	HP 8656B opt 001
Cable	BNC, 48 inch	HP 10503A
Cable	Type N (m), 24 inch	HP 11500B
Adapter	Type N (m) to BNC (f)	HP 1251-0780

- 1 Connect the signal generator to oscilloscope channel 1 input.
- 2 Set the signal generator to equal the full bandwidth of your oscilloscope, and set the output level to 0 dBm.
- 3 Connect the signal generator to oscilloscope channel 1. Set channel 1 Input to 50Ω to correctly terminate the signal generator.
- 4 Press **Autoscale**.
- 5 Adjust the oscilloscope controls and signal generator to obtain an 8-division high display.
- 6 Connect oscilloscope rear-panel VERT OUT to oscilloscope channel 2. Set channel 2 Input to 50Ω mode.
- 7 Measure the peak-to-peak amplitude of channel 2. It should be greater than or equal to 63.6 mVp-p.

Because the measurement is being made at the full bandwidth of the oscilloscope's channel, the peak-to-peak measurement is corrected for the oscilloscope's high frequency roll off.



**HEWLETT
PACKARD**

**HP 54600B
Performance Test Record**

Serial No. _____
Test Interval _____
Recommended Next Testing _____

Date _____
Test by _____
Work Order No. _____
Temperature _____

Output of dc calibrator	Limits	Result
	4.990 V to 5.010 V	_____

Voltage measurement accuracy			Channel 1	Channel 2
Range	Reading	Test Limits		
5 V/Div	35 V	34.24 V to 35.76 V	_____	_____
2 V/Div	14 V	13.70 V to 14.30 V	_____	_____
1 V/Div	7 V	6.848 V to 7.152 V	_____	_____
500 mV/Div	3.5 V	3.424 V to 3.576 V	_____	_____
200 mV/Div	1.4 V	1.370 V to 1.430 V	_____	_____
100 mV/Div	700 mV	684.8 mV to 715.2 mV	_____	_____
50 mV/Div	350 mV	342.4 mV to 357.6 mV	_____	_____
20 mV/Div	140 mV	137.0 mV to 143.0 mV	_____	_____
10 mV/Div	70 mV	68.48 mV to 71.52 mV	_____	_____
5 mV/Div	35 mV	34.48 mV to 35.52 mV	_____	_____
2 mV/Div	14 mV	12.48 mV to 15.52 mV	_____	_____

Bandwidth	Test Limits	Channel 1	Channel 2
	≤±3 dB	_____	_____

Horizontal Δt and 1/Δt accuracy			
	Reading	Test Limits	Results
Frequency	10 kHz	9.959 kHz to 10.04 kHz	_____
Period	100 μs	99.59 μs to 100.4 μs	_____
Frequency	1 MHz	995.7 kHz to 1.004 MHz	_____
Period	1 μs	995.7 ns to 1.004 μs	_____
Frequency	100 MHz	97.08 MHz to 103.1 MHz	_____
Period	10 ns	9.699 ns to 10.30 ns	_____

Trigger sensitivity	Test Limits	Channel 1	Channel 2
Internal trigger	25 MHz at 0.35 divisions	_____	_____
	100 MHz at 1 division	_____	_____
External trigger	100 MHz at 100 mV p-p	_____	_____
	25 MHz at 50 mV p-p	_____	_____



**HEWLETT
PACKARD**

HP 54601B

Performance Test Record

Serial No. _____

Test Interval _____

Recommended Next Testing _____

Date _____

Test by _____

Work Order No. _____

Temperature _____

Output of dc calibrator

Limits

4.990 V to 5.010 V

Result

Voltage measurement accuracy

Range	Reading	Test Limits	Channel 1	Channel 2	Channel 3	Channel 4
5 V/Div	35 V	34.24 V to 35.76 V	_____	_____	_____	_____
2 V/Div	14 V	13.70 V to 14.30 V	_____	_____	_____	_____
1 V/Div	7 V	6.848 V to 7.152 V	_____	_____	_____	_____
500 mV/Div	3.5 V	3.424 V to 3.576 V	_____	_____	_____	_____
200 mV/Div	1.4 V	1.370 V to 1.430 V	_____	_____	_____	_____
100 mV/Div	700 mV	684.8 mV to 715.2 mV	_____	_____	_____	_____
50 mV/Div	350 mV	342.4 mV to 357.6 mV	_____	_____	_____	_____
20 mV/Div	140 mV	137.0 mV to 143.0 mV	_____	_____	_____	_____
10 mV/Div	70 mV	68.48 mV to 71.52 mV	_____	_____	_____	_____
5 mV/Div	35 mV	34.48 mV to 35.52 mV	_____	_____	_____	_____
2 mV/Div	14 mV	12.48 mV to 15.52 mV	_____	_____	_____	_____

Bandwidth

Test Limits

≤±3 dB

Channel 1

Channel 2

Channel 3

Channel 4

Horizontal Δt and 1/Δt accuracy

	Reading	Test Limits	Results
Frequency	10 kHz	9.959 kHz to 10.04 kHz	_____
Period	100 μs	99.59 μs to 100.4 μs	_____
Frequency	1 MHz	995.7 kHz to 1.004 MHz	_____
Period	1 μs	995.7 ns to 1.004 μs	_____
Frequency	100 MHz	97.08 MHz to 103.1 MHz	_____
Period	10 ns	9.699 ns to 10.30 ns	_____

Trigger sensitivity

Test Limits

Internal trigger 25 MHz at 0.35 divisions

100 MHz at 1 division

Channel 1

Channel 2

Channel 3

Channel 4



**HEWLETT
PACKARD**

HP 54602B
Performance Test Record

Serial No. _____
Test Interval _____
Recommended Next Testing _____

Date _____
Test by _____
Work Order No. _____
Temperature _____

Output of dc calibrator	Limits	Result
	4.990 V to 5.010 V	_____

Voltage measurement accuracy			Channel 1	Channel 2	Channel 3	Channel 4
Range	Reading	Test Limits				
5 V/Div	35 V	34.24 V to 35.76 V	_____	_____	_____	_____
2 V/Div	14 V	13.70 V to 14.30 V	_____	_____	_____	_____
1 V/Div	7 V	6.848 V to 7.152 V	_____	_____	_____	_____
500 mV/Div	3.5 V	3.424 V to 3.576 V	_____	_____	_____	_____
200 mV/Div	1.4 V	1.370 V to 1.430 V	_____	_____	_____	_____
100 mV/Div	700 mV	684.8 mV to 715.2 mV	_____	_____	_____	_____
50 mV/Div	350 mV	342.4 mV to 357.6 mV	_____	_____	_____	_____
20 mV/Div	140 mV	137.0 mV to 143.0 mV	_____	_____	_____	_____
10 mV/Div	70 mV	68.48 mV to 71.52 mV	_____	_____	_____	_____
5 mV/Div	35 mV	34.24 mV to 35.76 mV	_____	_____	_____	_____
2 mV/Div	14 mV	13.70 mV to 14.30 mV	_____	_____	_____	_____
1 mV/Div	7 mV	6.696 mV to 7.304 mV	_____	_____	_____	_____

Bandwidth	Test Limits	Channel 1	Channel 2	Channel 3	Channel 4
	≤±3 dB	_____	_____	_____	_____

Horizontal Δt and 1/Δt accuracy			
	Reading	Test Limits	Results
Frequency	10 kHz	9.959 kHz to 10.04 kHz	_____
Period	100 μs	99.59 μs to 100.4 μs	_____
Frequency	1 MHz	995.7 kHz to 1.004 MHz	_____
Period	1 μs	995.7 ns to 1.004 μs	_____
Frequency	100 MHz	97.08 MHz to 103.1 MHz	_____
Period	10 ns	9.699 ns to 10.30 ns	_____

Trigger sensitivity	Test Limits	Channel 1	Channel 2	Channel 3	Channel 4
Internal trigger	25 MHz at 0.35 divisions	_____	_____	_____	_____
Channel 1 & 2	150 MHz at 1 division	_____	_____	_____	_____
Channel 3 & 4	250 MHz at 1 division	_____	_____	_____	_____

Option 005 voltage measurement accuracy	Test Limits	Channel 1	Channel 2
Amplitude peak-to-peak	≥63.6 mVp-p	_____	_____



**HEWLETT
PACKARD**

**HP 54603B
Performance Test Record**

Serial No. _____
Test Interval _____
Recommended Next Testing _____

Date _____
Test by _____
Work Order No. _____
Temperature _____

Output of dc calibrator	Limits	Result
	4.990 V to 5.010 V	_____

Voltage measurement accuracy			Channel 1	Channel 2
Range	Reading	Test Limits		
5 V/Div	35 V	34.04 V to 35.96 V	_____	_____
2 V/Div	14 V	13.62 V to 14.38 V	_____	_____
1 V/Div	7 V	6.808 V to 7.192 V	_____	_____
500 mV/Div	3.5 V	3.404 V to 3.596 V	_____	_____
200 mV/Div	1.4 V	1.362 V to 1.438 V	_____	_____
100 mV/Div	700 mV	680.8 mV to 719.2 mV	_____	_____
50 mV/Div	350 mV	340.4 mV to 359.6 mV	_____	_____
20 mV/Div	140 mV	136.20 mV to 143.8 mV	_____	_____
10 mV/Div	70 mV	68.08 mV to 71.92 mV	_____	_____
5 mV/Div	35 mV	33.08 mV to 36.92 mV	_____	_____
2 mV/Div	14 mV	12.08 mV to 15.92 mV	_____	_____

Bandwidth	Test Limits	Channel 1	Channel 2
	≤±3 dB	_____	_____

Horizontal Δt and 1/Δt accuracy			
	Reading	Test Limits	Results
Frequency	10 kHz	9.959 kHz to 10.04 kHz	_____
Period	100 μs	99.59 μs to 100.4 μs	_____
Frequency	1 MHz	995.7 kHz to 1.004 MHz	_____
Period	1 μs	995.7 ns to 1.004 μs	_____
Frequency	50 MHz	49.25 MHz to 50.77 MHz	_____
Period	20 ns	19.70 ns to 20.30 ns	_____

Trigger sensitivity	Test Limits	Channel 1	Channel 2
Internal trigger	25 MHz at 0.35 divisions	_____	_____
	60 MHz at 1 division	_____	_____
External trigger	60 MHz at 100 mV p-p	_____	_____
	25 MHz at 50 mV p-p	_____	_____

Adjusting the Oscilloscope

This section explains how to adjust the oscilloscope so that it is at optimum operating performance. You should perform the hardware adjustments periodically as indicated below.

- Hardware at 12 months or 2,000 hours of operation
- Firmware at 6 months or 1000 hours of operation, or if ambient temperature is greater than 10 °C from the calibration temperature, or if the user desires to maximize the measurement accuracy

The amount of use, environmental conditions, and your past experience with other instruments can help you to determine if you need a shorter adjustment interval.

Make sure you allow the oscilloscope to warm up for at least 30 minutes before you start the adjustments.

WARNING

SHOCK HAZARD!

The maintenance described in this section is performed with power supplied to the oscilloscope and with the protective covers removed. Only trained service personnel who are aware of the hazards involved should perform the maintenance. Whenever possible, perform the procedures with the power cord removed from the oscilloscope. Read the safety summary at the back of this book before proceeding. Failure to observe safety precautions may result in electric shock.

CAUTION

Do not disconnect any cables or remove any assemblies with the power applied to the oscilloscope, or damage to the oscilloscope can occur.

CAUTION

ELECTROSTATIC DISCHARGE (ESD) can damage electronic components. When using any of the procedures in this chapter you should use proper ESD precautions. As a minimum, you should place the instrument on a properly grounded ESD mat and wear a properly grounded ESD strap.

To adjust the power supply

On the power supply there is only one adjustment and that is for the +5.1 V. The other voltages are based on the +5.1 V adjustment. In this procedure you use a multimeter to measure the +5.1 V, and if necessary, you adjust the supply to within tolerance.

Table 4-12

Equipment Required

Equipment	Critical specifications	Recommended Model/Part
Digital multimeter	0.1 mV resolution, accuracy $\pm 0.05\%$	HP 34401A

- 1** Set up the oscilloscope for the voltage adjustment.
 - a** Turn off the oscilloscope and disconnect the power cord.
 - b** Remove the cover from the oscilloscope.
 - c** Place the oscilloscope on its side.
 - d** Connect the negative lead of the digital multimeter to a ground point on the oscilloscope.
 - e** Reconnect the power cord and turn on the oscilloscope.

2 Measure the power supply voltages at L1, L2, and L3 on the system board.

The test points are not marked on the system board; see figure below for location of test points.

Make sure that the voltage measurements are within the following tolerances.

Table 4-13

Power Supply Voltage Tolerances

+5.1 V	±150 mV (+4.95 V to +5.25 V)
+15.75 V	±787 mV (+14.96 V to +16.54 V)
-15.75 V	±787 mV (-14.96 V to -16.54 V)

Figure 4-1

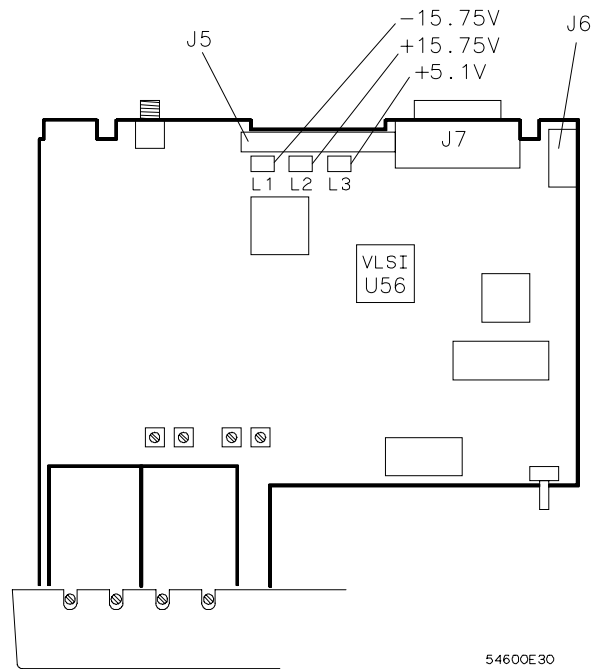

**Low Voltage Power Supply voltage test points
(bottom side of oscilloscope)**

Service
Adjusting the Oscilloscope

If the +5.1 V measurement is out of tolerance, adjust the +5.1 V adjustment on the power supply. The ± 15.75 V supplies are not adjustable and are dependent upon the +5.1 V supply. If adjusting the power supply does not bring all the voltages within tolerance, see "Troubleshooting the Oscilloscope," on page 4-40.

Figure 4-2

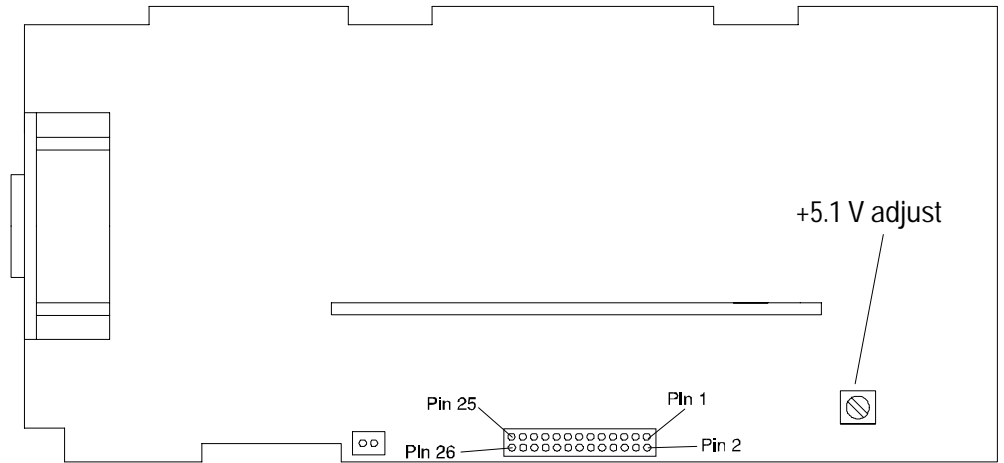

**Low Voltage Power Supply adjustment location
(top side of oscilloscope)**

To perform the self-calibration

In this procedure you load the default calibration factors to give a known starting point for the firmware calibration. *However, once the default calibration factors are loaded, you must perform the remainder of the firmware calibration to maintain the accuracy of the oscilloscope.*

Table 4-14

Equipment Required

Equipment	Critical specifications	Recommended Model/Part
Pulse generator	100 kHz, 1 V p-p, rise time <5 ns	HP 8112A
Cable	BNC, 3 feet	HP 10503A
Cable	BNC, 9 inches, Qty 2	HP 10502A
Adapter	BNC tee (m) (f) (f)	HP 1250-0781
Adapter	BNC (f-f)	HP 1250-0080
Feedthrough	50 Ω , BNC (m) and (f)	HP 10100C

1 Check the rear panel DC CALIBRATOR output level.

If you are not sure how to check the DC CALIBRATOR, see "To check the output of the DC CALIBRATOR," on page 4-6.

2 Load the default calibration factors.

- a Set the rear-panel **CALIBRATION** switch to **UNPROTECTED** (up position).
- b Press **Print/Utility** , then press the **Self Cal Menu** softkey.
- c Press the **Load Defaults** softkey.

Self-calibration hint

This instrument is self-calibrated at the factory. However, it should be self-calibrated again in its working environment after a 30-minute warmup to obtain the best accuracy.

Service
Adjusting the Oscilloscope

- Vertical self cal**
- 3** After the message "**Default calibration factors loaded**" is displayed on the lower left side of the display, press the **Vertical** softkey.
 - 4** Follow the instructions on the display, then press the **Continue** softkey.
The display prompts instruct you to connect the rear panel DC CALIBRATOR output first to channel 3, then to channel 1, then to channel 4, and finally to channel 2. (Channels 1 and 2 only on the HP 54600B and HP 54603B.)
 - 5** After the message "**Press Continue to return to calibration menu**" appears on the display, press the **Continue** softkey.
 - 6** Connect a pulse generator set to 100 kHz and 1 V p-p and with a rise time less than 5 ns to channels 1 and 2. Place the feedthrough at the BNC tee. Make sure you use the HP 10502A cables to ensure equal cable lengths.
- Delay self cal**
- 7** Press the **Delay** softkey, then follow the instructions on the display.
The display will instruct you to connect the signal simultaneously to channels 1 and 2, 1 and 3, 1 and 4, 2 and 4, 2 and 3, and finally to 3 and 4.
 - 8** Set the rear-panel **CALIBRATION** switch to **PROTECTED**.

To adjust the low-frequency compensation

In this procedure you adjust the low-frequency compensation adjustment for each channel.

Table 4-15

Equipment Required

Equipment	Critical specifications	Recommended Model/Part
Square wave generator	30 kHz at about 3 Vp-p	HP 8112A
Feedthrough	50 Ω , BNC (m) and (f)	HP10100C
Cable	BNC	HP 10503A

- 1** Turn off the oscilloscope and disconnect the power cord.
- 2** Remove the cover from the oscilloscope.
- 3** Reconnect the power cord and turn on the oscilloscope.
- 4** Using the BNC cable and 50- Ω feedthrough, connect the square wave generator to channel 1.
- 5** Adjust the generator for about 30 kHz at about 3 Vp-p.
- 6** Press Autoscale .
- 7** Set channel 1 to 500 mV/div.
You must perform this adjustment on the 500 mV range.
- 8** Adjust the output of the generator until you obtain about 5 to 6 divisions of vertical deflection.

Service
Adjusting the Oscilloscope

- 9 Adjust the channel 1 low-frequency compensation adjustment for as flat a pulse top as possible.
- 10 Repeat steps 4 through 9 for channel 2 (channels 2 to 4 on the HP 54601B and HP 54602B).

Figure 4-3

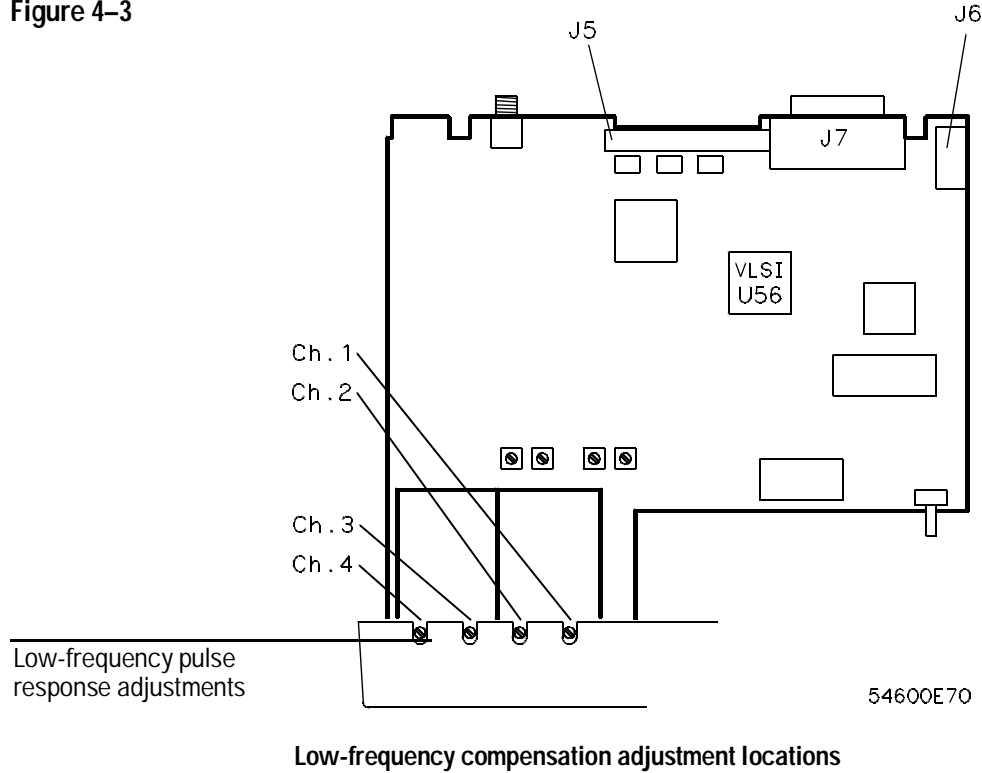

To adjust the high-frequency pulse response

In this procedure you adjust the high-frequency pulse response for each channel.

Table 4-16

Equipment Required

Equipment	Critical specifications	Recommended Model/Part
Pulse generator	Rise time < 875 ps	PSPL 1107B TD and PSPL 1110B Driver
Adapter	SMA (f) to BNC (m)	HP 1250-1787
Feedthrough	50 Ω , BNC (m) and (f)	HP 10100C

- 1** Turn off the oscilloscope and disconnect the power cord.
- 2** Remove the cover from the oscilloscope.
- 3** Reconnect the power cord and turn on the oscilloscope.
- 4** Connect the pulse generator to channel 1.
- 5** Press **Autoscale** .
- 6** Change the time base to 10 ns/div.
- 7** Press **1** , then toggle the Vernier softkey to On.
- 8** Adjust the Volt/Div until there are about 6 divisions of vertical deflection.

Service
Adjusting the Oscilloscope

- 9 Adjust the channel 1 high-frequency response for 1.5 minor division of overshoot (6%).
- 10 Repeat steps 4 through 9 for channel 2 (channels 2 to 4 on the HP 54601B and HP 54602B).

Figure 4-4

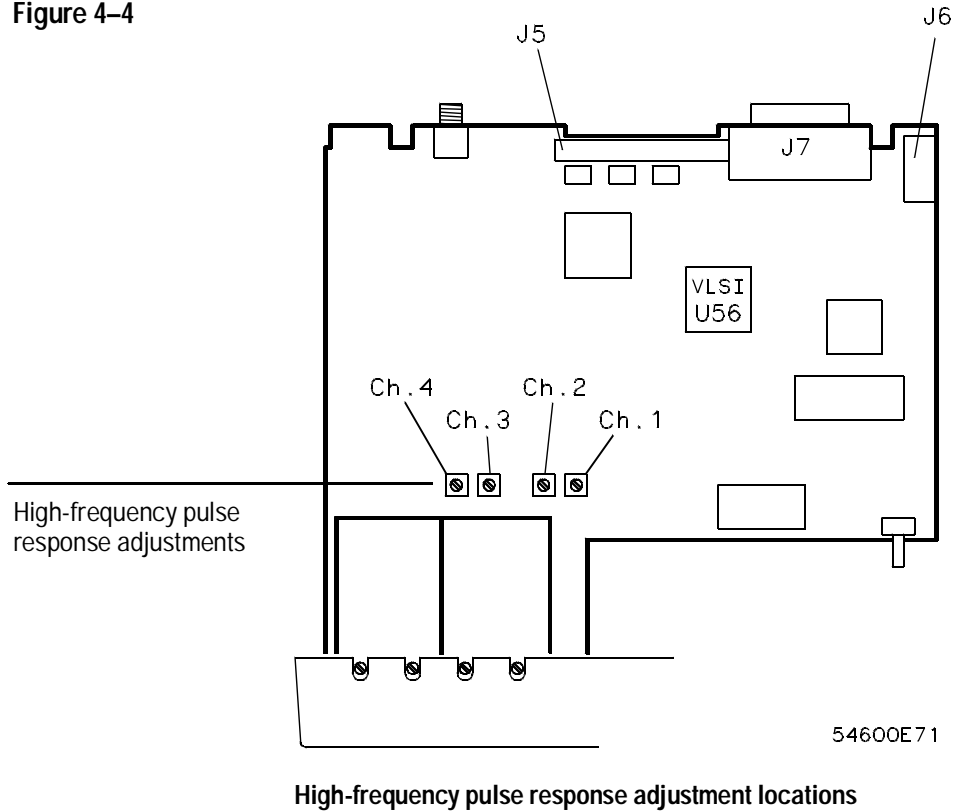

High-frequency pulse response adjustment locations

To adjust the display

When to adjust the display

The display adjustments are optional and normally do not require adjustment. You should use this procedure only for the few cases when the display is obviously out of adjustment.

Table 4-16

Equipment Required

Equipment	Critical specifications	Recommended Model/Part
Digital multimeter	Accuracy $\pm 0.05\%$, 1 mV resolution	HP 34401A

- 1 Turn off the oscilloscope and disconnect the power cord.
- 2 Remove the cover from the oscilloscope.
- 3 Reconnect the power cord and turn on the oscilloscope.
- 4 Connect the digital multimeter to the end of R901 closest to the fuse. See figure on next page.
- 5 Adjust +B for +14.00 V.
- 6 Press **Print/Utility** . Press the **Self Test** Softkey, then press the **Display** softkey.
- 7 Adjust V.HO (vertical hold) for vertical synchronization.
- 8 Set the intensity control (on the front panel) to mid-range.
- 9 Adjust Sub Bri (sub bright) to the lowest setting so that the half bright blocks on the display are visible.
- 10 Increase the intensity control to a comfortable viewing level.
This is usually about $\frac{3}{4}$ of its maximum range.

Service
Adjusting the Oscilloscope

- 11 Adjust HB Cont (half bright contrast) for the best contrast between the half bright and full bright blocks.

You can readjust Sub Bri, intensity control, and HB Cont to suit your individual preference.

- 12 Press any key to continue to the next test pattern. Then, adjust H.Hold (horizontal hold) to center the display horizontally.
- 13 Adjust Focus for the best focus.
- 14 Press any key to continue to the normal display pattern. Then adjust V.Lin (vertical linearity) for equal sizing of all four corner squares.
- 15 Adjust V.Size (vertical size) to center the display vertically at the maximum allowable size without losing the text.

Adjustments V.Lin and V.Size interact so you may need to readjust sizing and vertical centering of the display.

Figure 4-5

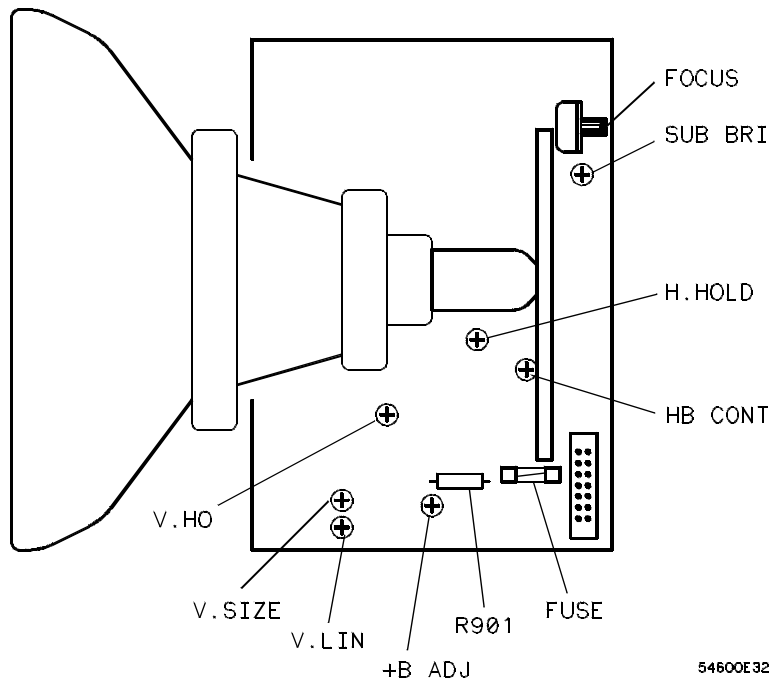

Display board adjustment locations

To adjust the Option 005 offset (R15) (HP 54602B only)

The oscilloscope must be calibrated before performing this adjustment. Refer to "To perform the self-calibration" on page 4-31.

Table 4-17

Equipment Required

Equipment Required	Critical Specification	Recommended Model/Part
Digital Multimeter	0.1 mV resolution, accuracy $\pm 0.05\%$	HP 34401A
Adapter	BNC (m) to dual banana post	HP 10110B

- 1** Set up the oscilloscope for the voltage adjustment.
 - a** Turn off the oscilloscope and disconnect the power cord.
 - b** Remove the cabinet from the oscilloscope.
 - c** Connect the negative lead of the digital multimeter to a ground point on the oscilloscope.
 - d** Connect the oscilloscope rear-panel VERT OUT connector to the voltage inputs of the digital multimeter (DMM) using the DMM's test leads and the BNC to dual banana post adapter.
 - e** Reconnect the power cord and turn on the oscilloscope
 - f** Setup the digital multimeter for a DC voltage measurement.
 - g** Press the **Setup** front panel key on the oscilloscope.
 - h** Press the **Default Setup** softkey on the oscilloscope.
- 2** Adjust R15 (below VERT OUT connector) on the Option 005 PC board so that the measured voltage on the digital multimeter is 0 volts ± 1 mV.

If adjusting R15 does not bring the voltage within tolerance, see "To troubleshoot Option 005" on page 4-48.

Troubleshooting the Oscilloscope

The service policy for this instrument is replacement of defective assemblies. The following procedures can help isolate problems to the defective assembly.

WARNING**SHOCK HAZARD!**

The maintenance described in this section is performed with power supplied to the oscilloscope and with the protective covers removed. Only trained service personnel who are aware of the hazards involved should perform the maintenance. Whenever possible, perform the procedures with the power cord removed from the oscilloscope. Read the safety summary at the front of this book before proceeding. Failure to observe safety precautions may result in electrical shock.

CAUTION

Do not disconnect any cables or remove any assemblies with the power applied to the oscilloscope, or damage to the oscilloscope can occur.

CAUTION

ELECTROSTATIC DISCHARGE (ESD) can damage electronic components. When using any of the procedures in this chapter you should use proper ESD precautions. As a minimum, you should place the instrument on a properly grounded ESD mat and wear a properly grounded ESD strap.

The following equipment is needed for troubleshooting the oscilloscope.

Table 4-18

Equipment Required

Equipment	Critical specifications	Recommended model/part
Digital multimeter	Accuracy $\pm 0.05\%$, 1 mV resolution	HP 34401A
Oscilloscope	100 MHz	HP 54600B
Probe	10:1 division ratio	HP 10432A
Dummy load ¹	Compatible with power supply	see note 1 below

¹ See page 4-41 to construct your own dummy load.

To construct your own dummy load

- 1 Obtain a connector compatible with the connector on the Low Voltage Power Supply.
- 2 Connect the following load resistors to the connector.
 - +5.1 V requires a 3 A load, 1.7 Ω and 15 W on pin 15, 17, or 19.
 - +15.75 V requires a 1.3 A load, 12.2 Ω and 20.5 W on pin 11 or 13.
 - With the fan operating, -15.75 V requires a 0.6 A load, 26.25 Ω and 9.5 W on pin 5 or 7.
 - Without the fan operating, -15.75 V requires a 0.8 A load, 26.25 Ω and 13 W on pin 5 or 7.
- 3 Connect the other end of the resistors to ground pins 2, 4, 6, and 8.

Figure 4-6

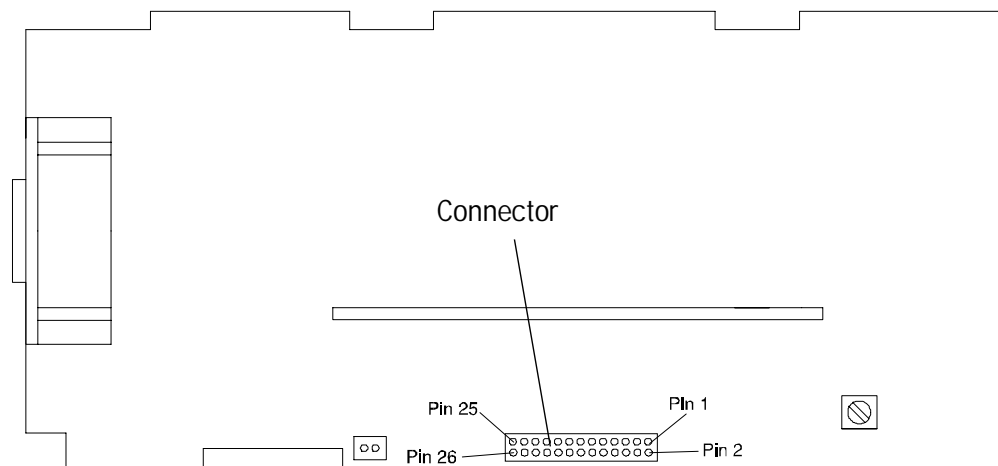

Low Voltage Power Supply connector pinout

To check out the oscilloscope

1 Is there an interface module connected to the oscilloscope?

If yes, do the following steps. If not, go to step 2.

- a** Turn off the oscilloscope.
- b** Remove the module.
- c** Turn on the oscilloscope, then check for the failing symptom.

If the failing symptom disappears, replace the module. If not, go to step 2.

2 Disconnect any external cables from the front panel.

3 Disconnect the power cord, then remove the cover.

4 Connect the power cord, then turn on the oscilloscope.

If the display comes on after a few seconds, (HP logo and copyright text, followed by a graticule with text at top of the display) go to "To check the Low Voltage Power Supply," on page 4-45. If after checking the Low Voltage Power Supply the voltages are within the test limits, go to step 8. If not, go to step 6. If the display did not come on, do the steps below.

- a** Check the intensity knob setting to see if it's set too low.
- b** If there is still no display, disconnect the power cord.
- c** Check all cable connections.
- d** Go to "To check the Low Voltage Power Supply," on page 4-45.

If the voltages are within the limits go to step 5. If not, go to step 6.

- 5** Disconnect the display cable, then check the following signals on the system board.

Table 4-18

Signals at U56				
	Signal	Frequency	Pulse width	Voltage
U16 Pin 7	DE	19.72 kHz	38.0 μ s	2.6 Vp-p
U16 Pin 24	Hsync	19.72 kHz	3.0 μ s	5.0 Vp-p
U9 Pin 2	Vsync	60.00 Hz	253.5 μ s	5.2 Vp-p

If the signals are good, replace the display assembly. If not, replace the system board.

- 6** Disconnect the Low Voltage Power Supply ribbon cable from the display board.
- 7** Measure the power supply voltages again (steps 1-3).

If the voltages are within the test limits, replace the display assembly. If not, do the steps below.

- a** Disconnect the power cord.
- b** Disconnect the ribbon cable from the power supply.
- c** Connect the dummy load to the power supply connector.
- d** Connect the power cord, then measure the power supply voltages again (see new tolerances below).

+5.1 V (4.95 V to +5.25 V)

+15.75 V (+15 V to +16.5 V)

-15.75 V (-15 V to -16.5 V)

If the voltages are now within the test limits, replace the system board. If not, replace the power supply.

Service
Troubleshooting the Oscilloscope

8 Is the fan running?

If yes, go to "To run the internal self-tests," on page 4-46. If not, do the steps below.

The Low Voltage Power Supply has a thermal cut-out circuit. If the fan is defective, the Low Voltage Power Supply shuts down when it gets too hot for safe operation.

- a** Disconnect the fan cable from the power supply.
- b** Measure the fan voltage at the connector on the power supply.
If the fan voltage is -8.3 Vdc, replace the fan. If not, replace the power supply.

To check the Low Voltage Power Supply

- 1 Disconnect the power cord, then set the oscilloscope on its side.
- 2 Connect the negative lead of the multimeter to a ground point on the oscilloscope. Connect the power cord and turn on the oscilloscope.
- 3 Measure the power supply voltages at L1, L2, and L3 on the system board.

Table 4-19

Power Supply Voltage Tolerances

Supply Voltage	Tolerance
+5.1 V	±150 mV (+4.95 V to +5.25 V)
+15.75 V	±787 mV (+14.96 V to +16.54 V)
-15.75 V	±787 mV (-14.96 V to -16.54 V)

Figure 4-7

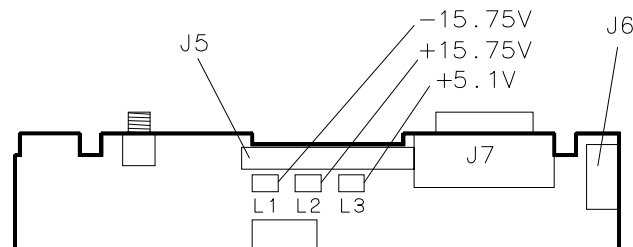

Low Voltage Power Supply voltage test points

If the +5.1 V measurement is out of the test limits, adjust the +5.1 V adjustment on the power supply. The ±15 V supplies are not adjustable and are dependent upon the +5.1 V supply.

Blown fuse

If the fuse is blown in the power supply, the power supply is defective. Replace the power supply.

To run the internal self-tests

- 1 Perform the keyboard test.
 - a Press **Print/Utility** .
 - b Press the **Self Tst** softkey, then press the **Keyboard** softkey.

A pictorial diagram of the front panel will appear on the display.
 - c Press each key, and notice that when you press a key a corresponding block on the display fills in.
 - d Rotate the knobs (except the intensity) and notice that an arrow appears on the display that points in the direction you rotate the knob.
 - e Do all the keys and knobs work?

If yes, Press the **Stop** softkey two or three times (the display indicates how many times), then go to step 2. If not, replace the keyboard and keyboard assembly.
- 2 Check the output level of the DAC.
 - a Press the **DAC** softkey.
 - b Connect a multimeter to the rear panel DC CALIBRATOR connector.

The multimeter should read $0\text{ V} \pm 500\ \mu\text{V}$.
 - c Press any key to continue.

The multimeter should read $5\text{ V} \pm 10\text{ mV}$.
 - d Are the DAC voltages correct?

If yes, press any key to continue. If not, replace the system board.
- 3 Perform the ROM test
 - a Press the **ROM** softkey.
 - b Does the display message say **Test Passed**?

If yes, press any key to continue. If not, (the display message says **Test Failed**) replace the system board.

- 4 Perform the RAM test.
 - a Press the **RAM** softkey.
 - b Does the display message say **Test Passed**?
If yes, press any key to continue. If not, (the display message says **Test Failed**) replace the system board.
- 5 Perform the display test.
 - a Press **Print/Utility** .
 - b Press the **Self Tst** softkey, then press the **Display** softkey.
 - c Do the half bright and full bright squares appear?
If yes, continue with the steps below. If not, replace the display.
 - d Press any key to continue.
 - e Do squares appear in the four corners?
If yes, the display is good. If not, replace the display.
 - f Press any key to end the test.
 - g If you still have the failing symptom, replace the system board.

To troubleshoot Option 005 (HP 54602B only)

To isolate a malfunction to the Option 005 board, do the following:

- 1** Disconnect the three cables that connect the Option 005 board to the system board.
- 2** Verify proper oscilloscope operation, as described in this chapter.
- 3** If the oscilloscope passes the performance verification and the malfunction still occurs when the Option 005 board is reconnected, then you should replace the Option 005 board.

Replacing Parts in the Oscilloscope

This section contains instructions for removing and ordering replaceable assemblies. Also in this section is a parts list for the assemblies and hardware of the oscilloscope that you can order from Hewlett-Packard.

Before working on the oscilloscope, read the safety summary at the back of this book.

WARNING

Hazardous voltages are on the CRT, power supply, and display sweep board. To avoid electrical shock, disconnect the power cord from the oscilloscope. Wait at least three minutes for the capacitors in the oscilloscope to discharge before you begin disassembling the oscilloscope.

CAUTION

Do not replace assemblies with the oscilloscope turned on or damage to the components can occur.

CAUTION

ELECTROSTATIC DISCHARGE (ESD) can damage electronic components. When using any of the procedures in this chapter you should use proper ESD precautions. As a minimum, you should place the instrument on a properly grounded ESD mat and wear a properly grounded ESD strap.

To replace an assembly

Refer to the exploded view of the oscilloscope, figure 4-11 (figure 4-12 for Option 005 board), for details on how the oscilloscope fits together. To install an assembly, follow the instructions in reverse order.

You will need the following tools to disassemble the oscilloscope:

- T15 TORX driver to remove the oscilloscope from the cabinet and to remove the fan.
- T10 TORX driver to remove the assemblies from the deck.
- Flat-blade screwdriver to remove the optional modules and the pouch.
- 9/16-inch nut driver or wrench to remove BNC nut.

1 Remove the oscilloscope from the cabinet.

- a** Turn off the oscilloscope and disconnect the power cable.
- b** If a module is installed, remove it from the oscilloscope.
- c** Using the T15 TORX driver, remove the two screws from the rear of the cabinet.
- d** Using your thumbs, gently push on the two rear-panel connectors to slide the oscilloscope out of the cabinet.

2 Remove the faulty assembly.

You can remove any of the following six assemblies: fan, front panel, display, system board, power supply, and keyboard.

To remove the fan

- 1 Disconnect the fan cable from the power supply board.
- 2 Using the T15 TORX driver, remove the three screws that hold the fan to the deck.

To remove the front panel

- 1 Remove the intensity knob by pulling straight out.
- 2 Disconnect the keyboard ribbon cable from the system board.
- 3 Use a screwdriver to release retainer tab A, and your finger to release retainer tab B. See figure on next page.

Releasing front panel from deck of instrument

When tab B is released, be careful that the sheet metal tab of front-panel ground input clears the softkey circuit board. The circuit board may be depressed slightly with a screwdriver to avoid damage to the circuit board.

- 4 Rotate the front panel out until the bottom clears the rear of the assembly, then lift the front panel to free the hooks on top.

Service
Replacing Parts in the Oscilloscope

When installing the front panel, make sure that the power switch shaft is aligned with its mating hole in the front panel.

The front panel swings in to engage the two retainer tabs. Before attempting to engage the retainer tabs, make sure that the six hooks on top of the front panel are fully engaged with their mating holes in the sheet metal.

Figure 4-8

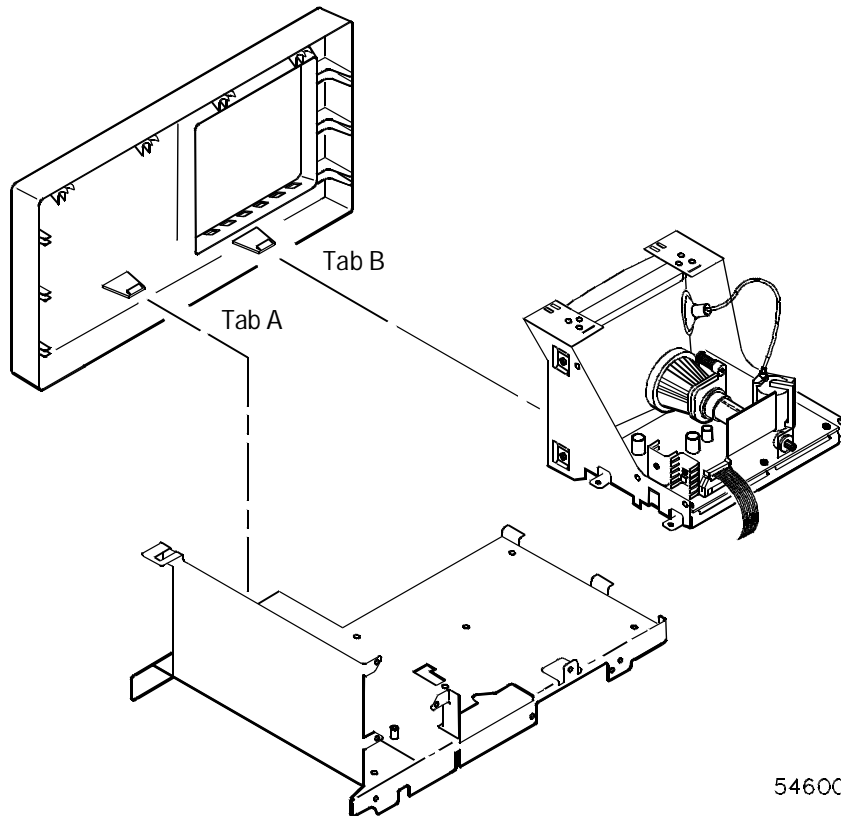

54600E31

Removing the front panel

To remove the display

- 1 Remove the front panel.
- 2 Disconnect the ribbon cable and the calibration cable from the display.
- 3 Using the T10 TORX driver, remove the two screws that hold the display to the deck.
Make sure that when you reinstall these screws that you use the correct parts. If longer screws are used, they can short the system board to ground.
- 4 As you lift the display, rotate it off the two tabs on the side of the deck.

To remove the system board

- 1 Using the T10 TORX driver, remove the eight screws that hold the system board to the deck (two of the screws are in the attenuator covers).
- 2 Remove the two screws from the rear-panel interface connector and the nut from the rear-panel BNC.
- 3 Disconnect the three ribbon cables and the calibration cable.
- 4 As you remove the system board, rotate the system board so that the BNCs clear the front panel.

Power supply

- 1 Remove the fan.
- 2 Disconnect the ground wire (green wire with the yellow stripe) from the deck.
- 3 Disconnect the ribbon cable from the power supply board.
- 4 Use a screw driver to gently unhook the latch that holds the white shaft to the power switch, then disconnect the shaft from the power switch. After you disconnect the shaft, make sure you position it in the recess along the side of the display bracket.

Figure 4-9

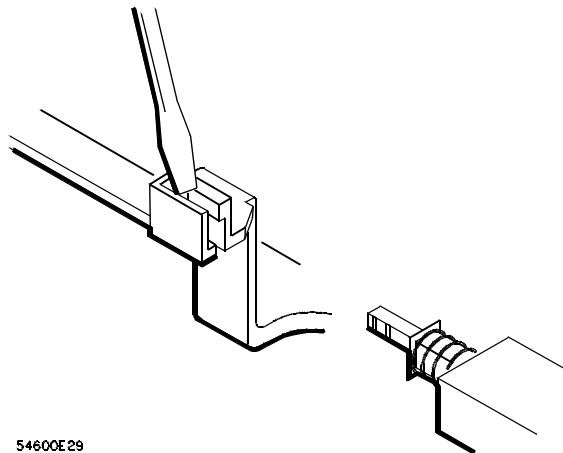

Removing the power switch shaft

- 5 Using the T10 TORX driver, remove the screw holding the power supply board to the deck.
- 6 Slide the power supply board towards the front panel about a half an inch. Slip the keyhole slots on the power supply board off of the pins on the deck.

Keyboard

- 1 Remove the front panel.
- 2 Remove all the knobs by pulling straight out.
- 3 Flex the bezel of the front panel to unsnap the small keyboard under the display opening.
- 4 Using the T10 TORX driver, remove the three screws from the large keyboard.

Make sure that when you reinstall these screws that you use the correct parts. If longer screws are used, they can damage the front-panel label.

- 5 Press down on the top of the keyboard, and rotate the bottom of the keyboard out.

When installing the keyboard, make sure that the probe calibration cable is kept away from the keyboard cable or noise can occur in the probe adjust signal. See figure below for positioning the keyboard cable.

Figure 4–10

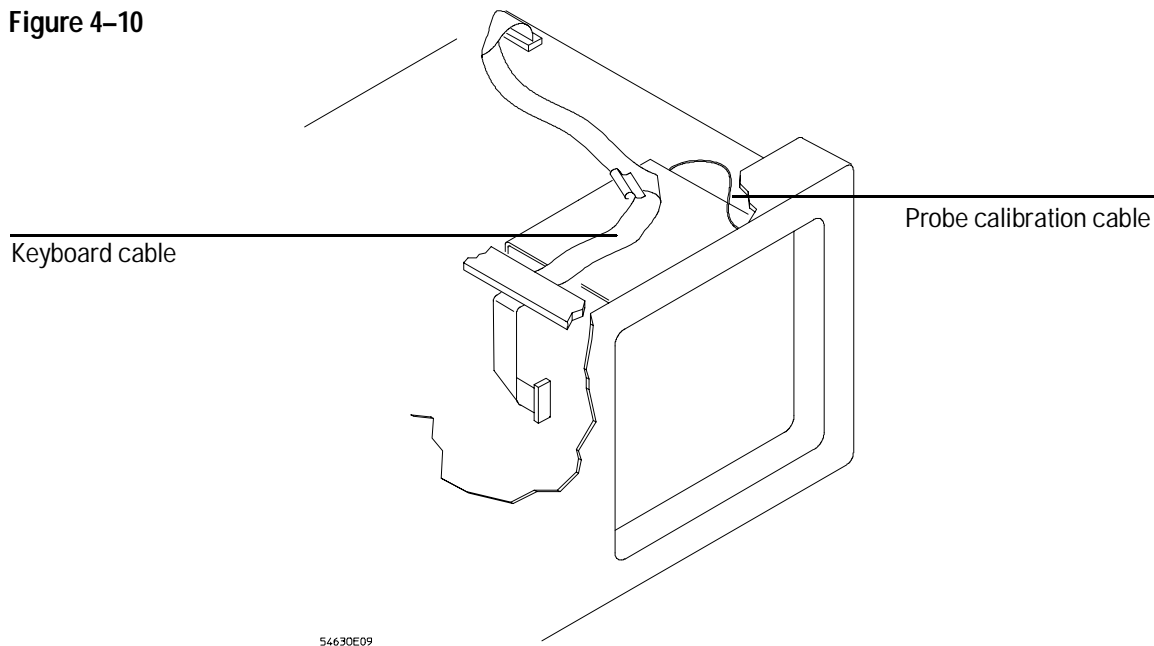

Positioning the keyboard cable

To remove the handle

- Rotate the handle down until it is just past the last detent position (about 1/2 inch before the handle touches the bottom of the oscilloscope), then pull the sides of the handle out of the cabinet.
-

To remove the Option 005 board

- 1 Remove the oscilloscope from the cabinet.
 - a Turn off the oscilloscope and disconnect the power cable.
 - b If a module is installed in the oscilloscope, remove it.
 - c Using the T15 TORX driver, remove the two screws from the rear of the cabinet.
 - d Using your thumbs, gently push on the two rear-panel connectors to slide the oscilloscope out of the cabinet.
 - 2 Remove the faulty Option 005 board.
 - a Using a T10 TORX driver, remove the two screws that lock the Option 005 board to the chassis.
 - b Slide the board back away from the front panel to release it from the keyholes.
 - c Disconnect the three cables attached to the Option 005 board.
 - d Remove the board from the keyholes, and from the oscilloscope.
-

To order a replacement part

The system board is part of an exchange program with Hewlett-Packard. The exchange program allows you to exchange a faulty assembly with one that has been repaired and performance verified by Hewlett-Packard.

After you receive the exchange assembly, return the defective assembly to Hewlett-Packard. A United States customer has 30 days to return the defective assembly. If you do not return the faulty assembly within the 30 days, Hewlett-Packard will charge you an additional amount. This amount is the difference in price between a new assembly and that of the exchange assembly. For orders not originating in the United States, contact your nearest Hewlett-Packard Sales Office for information.

Service

Replacing Parts in the Oscilloscope

- To order a part in the material list, quote the Hewlett-Packard part number, indicate the quantity desired, and address the order to your nearest Hewlett-Packard Sales Office.
- To order a part not listed in the material list, include the model number and serial number of the oscilloscope, a description of the part (including its function), and the number of parts required. Address the order to your nearest Hewlett-Packard Sales Office.
- To order using the direct mail order system, contact your nearest Hewlett-Packard Sales office.

Within the USA, Hewlett-Packard can supply parts through a direct mail order system. The advantages to the system are, direct ordering and shipment from the HP Parts Center in Mountain View, California. There is no maximum or minimum on any mail order. (There is a minimum amount for parts ordered through a local Hewlett Packard Sales Office when the orders require billing and invoicing.) Transportation costs are prepaid (there is a small handling charge for each order) and no invoices.

In order for Hewlett-Packard to provide these advantages, a check or money order must accompany each order. Mail order forms and specific ordering information are available through your local Hewlett-Packard Sales Office. Addresses and telephone numbers are located in a separate document shipped with the instrument.

Figure 4-11

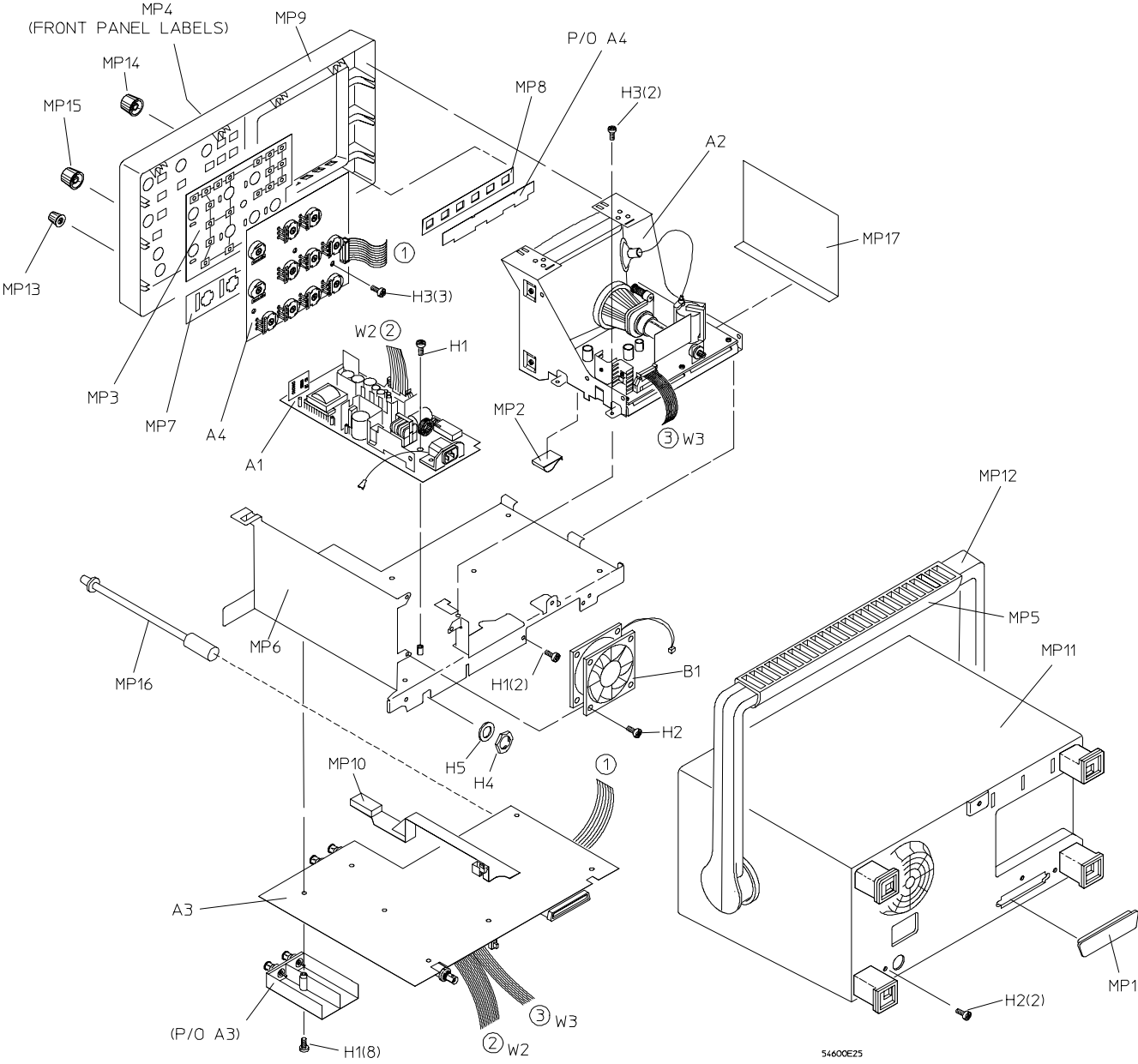

Exploded view of oscilloscope

Service
Replacing Parts in the Oscilloscope

Table 4-20

Replaceable Parts			
Reference Designator	HP Part Number	Qty	Description
A1	0950-2125	1	Power supply assembly
A2	2090-0316	1	Display assembly
A3	54600-66506	1	System board (HP 54600B only)
A3	54600-69506		Exchange system board (HP 54600B only)
A3	54601-66506	1	System board (HP 54601B only)
A3	54601-69506		Exchange system board (HP 54601B only)
A3	54602-66506	1	System board (HP 54602B only)
A3	54602-69506		Exchange system board (HP 54602B only)
A3	54603-66506	1	System board (HP 54603B only)
A3	54603-66506		Exchange system board (HP 54603B only)
A4	54600-66502	1	Keyboard (HP 54600B and HP 54603B only)
A4	54601-66502	1	Keyboard (HP 54601B and HP 54602B only)
B1	3160-1006	1	Fan
H1	0515-0372	11	Machine screw M3 X 8
H2	0515-0380	5	Machine screw M4 X 10
H3	0515-0430	5	Machine screw M3 X 6
H4	1250-2075	1	RF connector nut, 0.5 inch
H5	2190-0068	1	Lock washer
MP1	1251-2485	1	Connector dust cover
MP2	1400-1581	1	Cable clamp
MP3	54600-41901	1	Large keypad (HP 54600B and HP 54603B only)
MP3	54601-41901	1	Large keypad (HP 54601B and HP 54602B only)
MP4	54600-94306	1	Front-panel label (HP 54600B only)
MP4	54601-94306	1	Front-panel label (HP 54601B only)
MP4	54602-94301	1	Front-panel label - China (HP 54602B only)
MP4	54602-94306	1	Front-panel label (HP 54602B only)
MP4	54603-94301	1	Front-panel label (HP 54603B only)
MP5	54600-94307	1	Handle Label (HP 54600B only)
MP5	54601-94307	1	Handle Label (HP 54601B only)
MP5	54602-94307	1	Handle Label (HP 54602B only)
MP5	54603-94303	1	Handle Label (HP 54603B only)
MP6	54601-00102	1	Deck
MP7	54601-07101	1	EMI gasket

Reference Designator	HP Part Number	Qty	Description
MP8	54601-41902	1	Small rubber keypad
MP9	54645-42202	1	Front panel
MP10	54601-43701	1	Power-switch shaft
MP11	54601-64401	1	Cabinet (comes with handle and feet installed)
MP12	54601-44901	1	Handle
MP13	54601-47401	7	Small knob (HP 54600 has 6)
MP14	54601-47402	3	Large knob
MP15	54601-47403	1	Intensity knob
MP16	54601-47404	1	Small knob (dark)
MP17	5081-7741	1	Safety shield sheet
W1	8120-1521	1	Standard power cord
W1	8120-1703		Power cord option 900, United Kingdom
W1	8120-0696		Power cord option 901, Australia
W1	8120-1692		Power cord option 902, Europe
W1	8120-0698		Power cord option 904, 250 V, USA/Canada
W1	8120-2296		Power cord option 906, Switzerland
W1	8120-2957		Power cord option 912, Denmark
W1	8120-4600		Power cord option 917, Africa
W1	8120-4754		Power cord option 918, Japan
	Option 101		Accessory pouch and front-panel cover.
	5041-9411		Pouch
	54601-44101		Front-panel cover
Attenuator covers replacement parts (these are a part of the A3 system board)			
	54601-04101		Channel attenuator cover (one used on HP 54600B and HP 54603B, two used on HP 54601B and HP 54602B)
	0515-0667		M3 x 25 machine screw that holds attenuator cover to system board
	54645-21701		Spacer that goes between system board and attenuator cover. M3 x 25 machine screw goes through spacer.

Service
Replacing Parts in the Oscilloscope

Figure 4-12

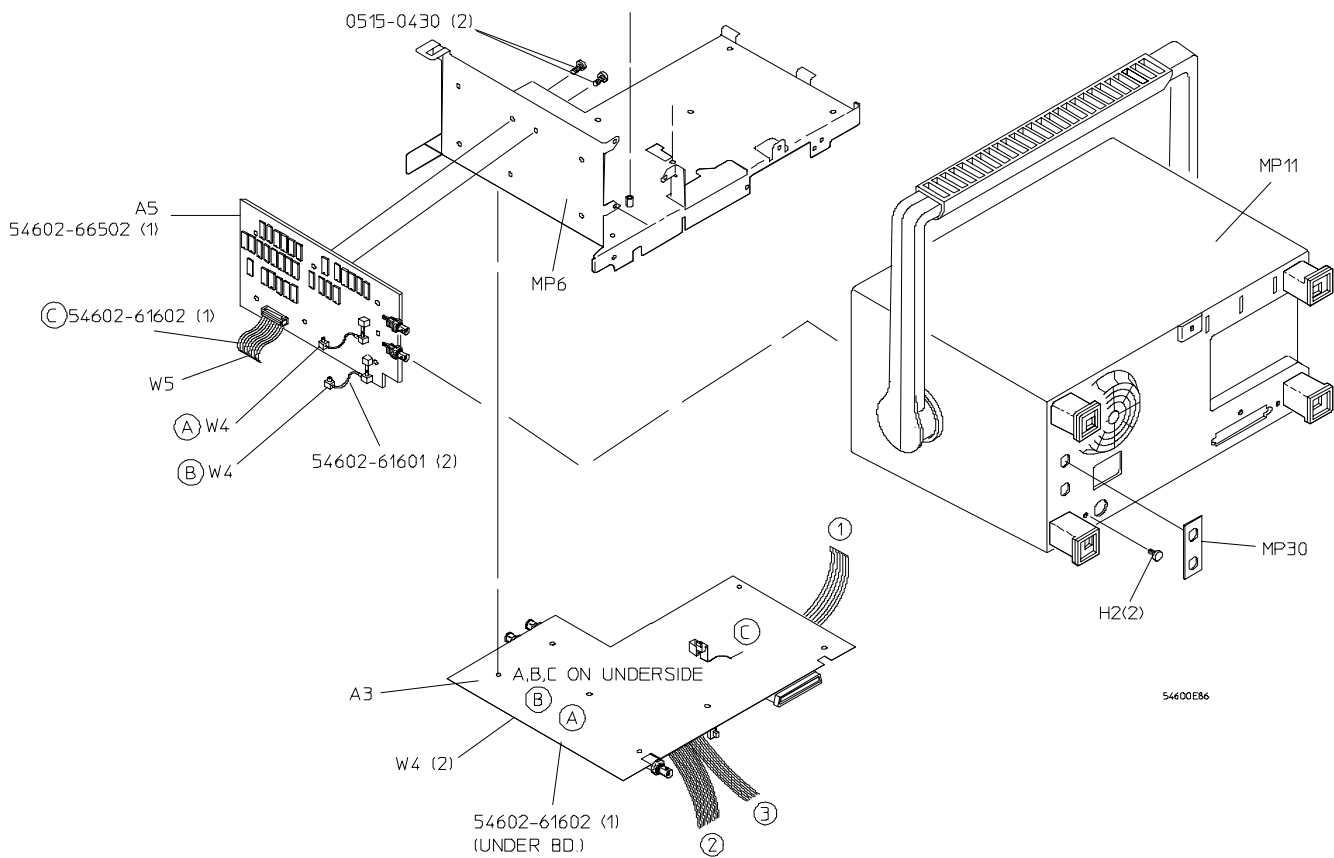

Exploded view of Option 005 and related oscilloscope parts

Table 4-21

Option 005 Replaceable Parts			
Reference Designator	HP Part Number	Qty	Description
A3	*	1	System Board (part of standard instrument)
A5	54602-66502	1	Video Trigger Board
H2	0515-0380	5	Machine screw M4 X 10 (part of standard instrument)
H3	0515-0430	7	Machine screw M3 X 6 (+2 screws for Option 005)
MP6	54601-00101	1	Deck (part of standard instrument)
MP11	54602-64402	1	Cabinet (comes with handle and feet installed – replaces standard cabinet)
MP30	54602-94305	1	Label, rear panel video trigger
W4	54602-61601	2	RF cable
W5	54602-61602	1	Ribbon cable
	HP 11094B	1	75Ω Termination

* See the oscilloscope Replaceable Parts table for the HP part number of the A3 System Board.

Performance Characteristics

Performance Characteristics

The performance characteristics describe the typical performance of the oscilloscope. You will notice that some of the characteristics are marked as tested, these are values that you can verify with the performance tests under "Verifying Oscilloscope Performance," on page 4-5.

Vertical System

All channels

Bandwidth¹

HP 54600B and HP 54601B

dc to 100 MHz -3 dB
ac coupled, 10 Hz to 100 MHz -3 dB

HP 54602B

dc to 100 MHz -3 dB (1, 2, & 5 mV/div)
dc to 150 MHz -3 dB (channels 1 & 2)
dc to 250 MHz -3 dB (channels 3 & 4)
ac coupled, 10 Hz to 150 MHz -3 dB (channels 1 & 2)

HP 54603B

dc to 60 MHz -3 dB
ac coupled, 10 Hz to 60 MHz

Rise time

3.5 ns (calculated, HP 54600B & HP 54601B)
<2.33 ns (calculated, channels 1 & 2, HP 54602B)
<1.4 ns (calculated, channels 3 & 4, HP 54602B)
5.8 ns (calculated, HP 54603B)

Dynamic range ± 32 V or ± 8 divisions, whichever is less

Math functions Channel 1 + or - channel 2

Input resistance 1 M Ω

Input capacitance ≈ 13 pf



Maximum input voltage 400 V (dc + peak ac)

¹ Tested, see "To verify bandwidth," on page 4-10.

Performance Characteristics
Vertical System

Channels 1 and 2

Range 2 mV/div to 5 V/div (lower limit is 1 mV/div for the HP 54602B)

Accuracy¹ ±1.9% (HP 54600B, HP 54601B, and HP 54602B)
±2.4% (HP 54603B)

Verniers¹ Fully calibrated, accuracy about ±3.5%

Cursor accuracy^{1, 2, 3}

Single cursor accuracy vertical accuracy ±1.2% of full scale ±0.5% of position value (HP 54602B at <10 mV/div: vertical accuracy ±2.4% of full scale ±0.5% of position value)

Dual cursor accuracy vertical accuracy ±0.4% of full scale

Bandwidth limit ≈20 MHz

Coupling Ground, ac, and dc

Inversion Channel 1 and channel 2

CMRR (common mode rejection ratio) ≈ 20 dB at 50 MHz

Channels 3 and 4

(HP 54601B & HP 54602B only)

Range 0.1 V/div and 0.5 V/div ranges

Accuracy¹ ±1.5%

Coupling Ground and dc

¹ When the temperature is within ±10 °C from the calibration temperature.

² Use a full scale of 16 mV for 1 mV/div range for HP 54602B.

Use a full scale of 80 mV for 2 mV/div and 5 mV/div ranges for all other scopes.

³ Tested, see "To verify voltage measurement accuracy," on page 4-7.

Horizontal System

Sweep speeds

5 s/div to 2 ns/div main and delayed (HP 54600B, HP 54601B,
HP 54602B)

5 s/div to 5 ns/div main and delayed (HP 54603B)

Accuracy $\pm 0.01\% \pm 0.2\%$ of full scale ± 200 ps

Vernier Accuracy $\pm 0.05\%$

Horizontal resolution 100 ps

Cursor accuracy^{1,2} (Δt and $1/\Delta t$) $\pm 0.01\% \pm 0.2\%$ of full scale ± 200 ps

Delay jitter 10 ppm

Pretrigger delay (negative time) ≥ 10 divisions

Posttrigger delay (from trigger point to start of sweep) at least 2560 divisions or 50 ms. Not to exceed 100 s.

Delayed sweep operation

Main sweep	Delayed sweep
5 s/div to 10 ms/div	up to 200 times main sweep
5 ms/div and faster	up to 2 ns/div

¹ Use full scale of 50 ns on 2 ns/div range.

² Tested, see "To verify horizontal Δt and $1/\Delta t$ accuracy," on page 4-16.

Trigger System

Internal trigger

Sensitivity¹

HP 54600B	dc to 25 MHz	0.35 div or 3.5 mV
	dc to 100 MHz	1 div or 10 mV
HP 54601B	dc to 25 MHz	0.35 div or 3.5 mV
	dc to 100 MHz	1 div or 10 mV
HP 54602B	dc to 25 MHz	0.35 div or 3.5 mV (>5 mV/div)
		1.0 div or 2 mV (1, 2, or 5 mV/div)
	25 MHz to 100 MHz	1.5 div or 3 mV (1, 2, or 5 mV/div)
	dc to 150 MHz	1 div or 10 mV (chan 1&2)(>5 mV/div)
HP 54603B	dc to 250 MHz	1 div or 100 mV (chan 3&4)
	dc to 25 MHz	0.35 div or 3.5 mV
	dc to 60 MHz	1 div or 10 mV

Sources Channels 1, 2, 3, 4, and line on HP 54601B & HP 54602B
Channels 1, 2, line, and external on HP 54600B and HP 54603B

Coupling ac, dc, LF reject, HF reject, and noise reject
LF reject and HF reject -3 dB at ≈50 kHz

Modes Auto, Autolevel, Normal, Single, and TV

TV triggering Available on channels 1 and 2 only

TV line and field 0.5 division of composite sync for stable display

Holdoff Adjustable from 200 ns to ≈13 s

External trigger (HP 54600B and HP 54603B only)

Range ± 18 V

Sensitivity¹

HP 54600B dc to 25 MHz 50 mV
dc to 100 MHz 100 mV

HP 54603B dc to 25 MHz 50 mV
dc to 60 MHz 100 mV

Coupling dc, HF reject, and noise reject

Input resistance 1 M Ω

Input capacitance ≈ 13 pf



Maximum input voltage 400 V (dc + peak ac)

¹ Tested, see "To verify trigger sensitivity," on page 4-18.

XY Operation

XY Operation

Z Blanking TTL high blanks trace

Bandwidths X and Y same as vertical system

Phase difference ± 3 degrees at 100 kHz

Display System

Display 7-inch raster CRT

Resolution 255 vertical by 500 horizontal points

Controls Front-panel intensity control

Graticule 8 \times 10 grid or frame

Autostore Autostore saves previous sweeps in half bright display and the most recent sweep in full bright display.

Acquisition System

Maximum sample rate 20 MSa/s

Resolution 8 bits

Simultaneous channels Channels 1 and 2 or channels 3 and 4

Record length

Vectors off 4,000 points

Vectors on and/or single shot 2,000 points

Maximum update rate

Vectors off 1,500,000 points/sec

Vectors on 60 full screens/sec, independent of the number of waveforms being displayed

Single-shot bandwidth 2 MHz single channel, 1 MHz dual channel

Peak detect 50 ns glitch capture (100 ns dual channel) from 5 s/div to 50 μ s/div

Average Number of averages selectable at 8, 64, and 256

Roll Mode At sweep speeds of 200 ms/div and slower, waveform data moves across the display from right to left with no dead time.

Display can be either free-running (non-triggered) or triggered to stop on a trigger event.

Advanced Functions

Automatic measurements (measurements are continuously updated)

Voltage V_{avg} , V_{rms} , V_{p-p} , V_{top} , V_{base} , V_{min} , V_{max}

Time Frequency, period, + width, – width, duty cycle, rise time, and fall time

Cursors Manually or automatically placed

Setup functions

Autoscale Sets vertical and horizontal deflections and trigger level for signals with a frequency ≥ 50 Hz, duty cycle $> 1\%$, and voltage level channels 1 and 2 > 20 mVp-p, channels 3 and 4 > 100 mVp-p, external trigger (HP 54600B and HP 54603B only) > 100 mVp-p.

Save/Recall 16 front-panel setups

Trace memory Two volatile pixel memories

Power Requirements

Line voltage range 100 Vac to 240 Vac

Line voltage selection Automatic

Line frequency 45 Hz to 440 Hz

Maximum power consumption 220 VA

General

Environmental characteristics

The instrument meets or exceeds the environmental requirements of MIL-T-28800D for Type III, Class 3, Style D equipment as described below.

Ambient temperature (Tested to MIL-T-28800D paragraphs 4.5.5.13 option 2 and 4.5.5.14)

Operating -10 °C to +55 °C

Nonoperating -51 °C to +71 °C

Humidity (tested to Hewlett-Packard environmental specification section 758 paragraphs 4.0, 4.1, and 4.2 for class B-1 products)

Operating 95% relative humidity at +40 °C for 24 hours

Nonoperating 90% relative humidity at +65 °C for 24 hours

Altitude (Tested to MIL-T-28800E paragraph 4.5.5.2)

Operating to 4,500 m

Nonoperating to 15,000 m

EMI

EMI (commercial) CISPR 11 (ISM, Group 1, class A equipment)

EMI Meets the requirements in accordance with MIL-T-28800D,

CE01 Part 2 narrow band requirements up to 15 kHz

CE03 Part 4

CS01 Part 2

CS02 Part 2

CS06 Part 5 limited to 300 V

Performance Characteristics

General

RE01 Parts 5 and 6 measured at 30.5 cm, 15 dB relaxation to 20 kHz, and exceptioned from 20 kHz to 50 kHz.

RE02 Part 2 (limited to 1 GHz) Full limits of class A1c and A1f, with option 002 installed without option 002 installed 10 dB relaxation, 14 kHz to 1 GHz

RS02 Part 2, Part I Exceptioned

RS02 Part 2, Part II Exceptioned

RS03 Part 2, limited to 1 V/meter from 14 kHz to 1 GHz (with option 001 installed) Slight trace shift from 80 MHz to 200 MHz

Vibration

Operating 15 minutes along each of the 3 major axes; 0.635 mm p-p displacement, 10 Hz to 55 Hz in one-minute cycles. Held for 10 minutes at 55 Hz (4 g at 55 Hz).

Shock

Operating 30 g, 1/2 sine, 11 ms duration, 3 shocks per axis along major axis. Total of 18 shocks.

Physical characteristics

Size (excluding handle)

Height 172 mm

Width 322 mm

Depth 317 mm

Weight 6.2 kg

Option 005 General Performance Characteristics (HP 54602B only)

Video Standards

NTSC
PAL
PAL-M
SECAM
Generic

Video Trigger Modes

Line (number) of Field 1
Field 2
Alternate Fields

All Lines

Field 1 Defined as that field with the 3 lines of vertical sync starting at line 4. Is actually color field 1 or color field 3.

Field 2 Defined as that field with the 3 lines of vertical sync starting at the midpoint of line 3. Is actually color field 2 or color field 4.

All Fields

Option 005 Trigger System (HP 54602B only)

Internal trigger	Sensitivity Performance remains unchanged
	Coupling Performance remains unchanged
	Modes Performance remains unchanged
	Holdoff Performance remains unchanged
	TV triggering Available on channels 1 and 2 only
	TV line and field 0.5 division of composite sync for stable display
External trigger	Performance remains unchanged
Vertical output	Connector Rear panel BNC (f)
	Source Impedance 50 Ω (nominal)
	Signal source selected by internal trigger source
	Amplitude approximately 90mVp-p into 50 Ω for a full scale display at full bandwidth of the oscilloscope
TV Trigger output	Connector Rear panel BNC (f)
	Amplitude TTL
	Pulse width a function of TV trigger mode, Minimum approximately 5 μ s in line modes to the width of a field in field modes
	Delay from Vertical Output approximately 400ns.

Glossary

This glossary is organized into two parts: oscilloscope and TV/video trigger terms. The TV/video trigger terms apply to the HP 54602B with Option 005 installed.

Oscilloscope Terms

Auto A trigger mode that produces a baseline display if the trigger conditions are not met. If the trigger frequency is less than 25 Hz, even if the level and slope conditions are met, a free running display will result.

Auto Level The oscilloscope sets the trigger point to the 50% amplitude point on the displayed waveform. If there is no signal present, a baseline is displayed.

Autoscale Front-panel key that automatically sets up the oscilloscope to display a signal.

Autostore displays the stored waveforms in half bright, and the most recent trace is displayed in full bright.

Baseline Free running trace on the display when no signal is applied and the trigger mode is set to auto or auto level.

BW Lim (Bandwidth Limit) Limits the displayed bandwidth of the selected channel to 20 MHz, and is available for channels 1 and 2 only. This feature is useful for viewing noisy signals

Coupling (Coupling) For the channels, it changes the input coupling. Channels 1 and 2 allow dc, ac, or ground, while channels 3 and 4 allow dc or ground. In the trigger menu, it toggles between dc and ac for trigger coupling.

Cursors Horizontal and vertical markers used for making custom voltage and time measurements.

Delay In main sweep, the delay knob moves the sweep horizontally, and indicates how far the time reference is from the trigger point. In delayed sweep the delay knob moves the starting point of the portion of the main sweep to be expanded by the delayed sweep.

Delayed Gives an expanded view of the main sweep.

Display Allows selection of either normal, peak detect, or averaged display modes.

Erase Clears the display.

Glossary

External Trigger Is available only on the two channel oscilloscope. Nonviewable input that is usable as a trigger source only.

Field 1 Triggers on the field 1 portion of the video signal.

Field 2 Triggers on the field 2 portion of the video signal.

HF Reject (high frequency reject) Adds a low pass filter with a 3 dB point at 50 KHz to the trigger path.

Holdoff Keeps the trigger from rearming for an amount of time set by the holdoff knob.

Internal Trigger The oscilloscope triggers from a channel input that you choose.

Invert Invert shifts the displayed waveform 180 degree, and is available for channels 1 and 2 only. When the oscilloscope is triggered on the signal to be inverted, the trigger is also inverted.

Level Front-panel knob that changes the trigger level.

LF Reject (low frequency reject) Adds a high pass filter with a 3 dB point at 50 KHz to the trigger path.

Line In TV trigger mode, the oscilloscope triggers on the TV line sync pulses. As a trigger source, the oscilloscope triggers off of the power line frequency.

Main Sets the oscilloscope to a volts vs time display that displays the main time base sweep.

Mode Allows you to select one of five trigger modes, Auto level, Auto, Normal, Single, TV.

Noise Rej (noise reject) Decreases the trigger sensitivity to reduce the triggering on signal noise.

Normal If a trigger signal is present and the trigger conditions are met, a waveform is displayed. If there is no trigger signal, the oscilloscope does not trigger and the display is not updated.

Peak Det (peak detect) Allows detection of signal extremes as the sample rate is decreased in the 5 s to 50 ms/div time base settings.

Polarity Selects either positive or negative TV sync pulses.

Position Knob that moves the signal vertically on the display.

Print/Utility Allows access to the module menus and service menus.

Probe Allows selection of 1, 10, or 100 to match a probe's division ratio so that the vertical scaling and voltage measurements reflect the actual voltage levels at the tip of the probe.

Recall Recalls a selected front-panel setup that you saved to one of 16 memory location. Memory selection is with either a softkey or the knob closest to the Cursors front-panel key.

Recall Setup Recalls the front-panel setup that was saved with a waveform.

Run The oscilloscope acquires data and displays the most recent trace.

Save Saves the current front-panel setup to one of the possible 16 memory locations. Memory selection is with either a softkey or the knob closest to the Cursors front-panel key.

Setup Allows access to front-panel setup keys.

Single (single shot) The oscilloscope triggers once when the trigger conditions are met. The oscilloscope must be rearmed before the oscilloscope retriggers by pressing either the Run or Autostore front-panel keys.

Slope/Coupling Allows access to the trigger slope and input coupling menus.

Slope Selects either the rising or falling edge of the signal to trigger the oscilloscope.

Source Allows you to select a trigger source.

Stop Freezes the display.

Time Allows access to the automatic time measurement keys.

Time/Div Changes the time base in a 1-2-5 step sequence from 2 ns to 5 s.

Time Ref Lft Cntr (time reference left or center) Sets the time reference to either one graticule in from the left edge of the display or to center of the display.

Glossary

Trace Allows access to the trace storage keys.

Trace Mem (trace memory) One of two pixel memory locations used for storing traces.

TV Allows access to the TV slope and trigger coupling keys.

Vernier Vernier allows a calibrated fine adjustment with the channel 1 and 2 Volts/Div knob, and the time base Time/Div knob.

Voltage Allows access to the automatic voltage measurement keys.

Volts/Div Changes the vertical scaling in a 1-2-5 step sequence from 2 mV to 5 V.

XY Changes the display to a volts versus volts display.

TV/Video Trigger Terms

Blanking Level The level of the composite picture signal that separates the range containing picture information from the range containing synchronizing information. (IEEE Definition)

Chrominance That property of light which produces a sensation of color in the human eye apart from any variation in luminance that may be present.

Chrominance Signal That portion of the color television signal which contains the color information. (STOC Definition)

Color Burst In color systems, this normally refers to a burst of subcarrier frequency (8 to 10 cycles of 3.579545 MHz in NTSC systems) on the back porch of the composite video signal used to establish a frequency and phase reference for the chrominance signal.

Composite Sync The line and field rate synchronizing pulses (including the field equalizing pulses), when combined together, form the composite sync signal.

Composite Video For color, this consists of blanking, field, and line synchronizing signals, color synchronizing signals, plus chrominance and luminance picture information. These are all combined to form the complete color video signal.

Equalizing Pulses Pulses of one half the width of the horizontal sync pulses which are transmitted at twice the rate of the horizontal sync pulses during the portions of the vertical blanking interval immediately preceding and following the vertical sync pulse. These pulses cause the vertical deflection to start at the same time in each interval. They also keep the horizontal sweep circuits in step during the portions of the vertical blanking interval immediately preceding and following the vertical sync pulse.

Field One of the two (or more) equal parts of information into which a frame is divided in interlace scanning; alternately, one half of a complete picture (or frame) interval, containing all of the odd, or all of the even, lines of the picture.

Field 1 Triggers on the field 1 portion of the video signal.

Field 2 Triggers on the field 2 portion of the video signal.

Frame One complete picture consisting of two fields of interlaced scanning lines.

HF Reject (high frequency reject) Adds a low pass filter with a 3 dB point at 50 KHz to the trigger path.

Holdoff Keeps the trigger from re-arming for an amount of time set by the holdoff knob.

Internal Trigger The oscilloscope triggers from a channel input that you choose.

Invert Invert shifts the displayed waveform 180 degree, and is available for channels 1 and 2 only. When the oscilloscope is triggered on the signal to be inverted, the trigger is also inverted.

IRE An abbreviation for Institute of Radio Engineers.

IRE Scale An oscilloscope scale that applies to composite video levels. There are 140 IRE units in one volt.

Glossary

Line In TV trigger mode, the oscilloscope triggers on the TV line sync pulses. As a trigger source, the oscilloscope triggers off of the power line frequency.

Luminance The amount of light intensity, which is perceived by the eye as brightness (referred to as "Y")

Main Sets the oscilloscope to a volts vs time display that displays the main time base sweep.

Mode Allows you to select one of five trigger modes, Auto level, Auto, Normal, Single, TV.

Noise Rej (noise reject) Decreases the trigger sensitivity to reduce the triggering on signal noise.

NTSC National Television Systems Committee. An industry-wide engineering group which, during 1950-1953, developed the color television specifications now established in the United States, Canada, Japan, and Mexico. A 525 line, 60 Hz field, 4.2 MHz system. Two frames (4 fields) for picture completion.

PAL Phase Alternating Line or Phase Alteration Line rate. Color television standards used in Europe. A 625 line, 50 Hz field system. Eight fields for picture completion.

PAL-M Phase Alternating Line or Phase Alteration Line rate. A version of the European system adapted to a 525 line, 60 Hz field, 4.2 MHz bandwidth used in Brazil.

SECAM SEquentiel Couleur Avec Memoire. An acronym derived from the French phrase meaning Sequential Color with Memory. Color television specifications used primarily in France and the former Soviet Union. A 625 line, 50 Hz field, wide bandwidth system. Two frames (4 fields) required for picture completion

Sync An abbreviation for the words "synchronization," "synchronizing," etc. Applies to the synchronization signals, or timing pulses, which lock the electron beam of the picture monitors in step, both horizontally and vertically, with the electron beam of the pickup tube. The color sync signal (NTSC) is known as the color burst.

Vertical Blanking Interval The blanking portion at the beginning of each field. It contains the equalizing pulses, the vertical sync pulses, and VITS (if desired). Presently 18 to 21 lines in duration.

Vertical Interval Reference (VIR)

A signal used as a reference for amplitude and phase characteristics of a color television program (FCC assigned to line 19).

Vertical Interval Test Signal

A signal which may be included during the vertical blanking interval to permit in-service testing and adjustment of video transmission.

Index

A

ac coupling, 1-10, 1-14, 5-4, 5-6
accuracy
 cursors, 5-4 to 5-5
 horizontal, 5-5
 vertical, 5-4
acquisition characteristics, 5-9
Active Cursor, 2-22
adjustments
 display, 4-37 to 4-38
 high frequency, 4-27 to 4-39
 low frequency, 4-27 to 4-39
 power supply, 4-28 to 4-29
advance functions, 5-10
All Fields, 3-9
Alt Fld
 See alternate fields
alternate fields, 3-5
altitude characteristics, 5-11
ambient temperature, 4-27, 5-11
assembly replacement, 4-50
Auto, 1-15
auto level, 1-15
Auto Level softkey, 1-15
Auto softkey, 1-14
automatic measurement, 3-14
automatic measurements
 time, 2-16 to 2-18
 voltage, 2-19 to 2-21
autoscale
 characteristics, 5-10
 to autoscale, 1-9
 Undo, 1-9, 2-33
 video, 3-4, 3-12, 3-16
autostore, 2-6 to 2-7, 2-9 to 2-10
Av, 2-30
Average softkey, 2-30
averaging, 2-30, 5-9

B

bandwidth
 characteristics, 5-2
 limit, 5-4
 single shot, 2-9, 5-9
 to verify, 4-10, 4-12
XY, 5-8

C

calibration
 adjustments, 4-27 to 4-39
 delay, 4-32
 self, 4-31 to 4-32
 vertical, 4-32
channel signal connection, 1-7
channels
 preset configuration, 2-33
characteristics, 5-2, 5-4 to 5-8, 5-10 to 5-12
clamp circuit
 internal, 3-16
clamping
 external, 3-16
cleaning, 1-6
Clear Cursors softkey, 2-22
Clear Meas softkey, 2-17
clear measurement, 2-17
Clear softkey, 2-31
color burst, 2-41
compensation probe, 1-8
complex waveforms, 2-12
configuration
 preset default settings, 2-33
connect to instrument(s), 3-20
coupling, 5-14
 ac, 1-10, 1-14, 5-4, 5-6, 5-14
 dc, 1-10, 1-14, 5-4, 5-6
cursor
 active, 3-12
 clear, 3-12
 time, 3-12
 voltage, 3-12
cursor measurements, 2-22 to 2-25, 3-12 to 3-13
Cursors
 active, 2-22
 clear, 2-22
 preset configuration, 2-33
Cursors key, 2-22
custom measurements, 2-22, 3-12

D

DAC softkey, 4-6
DC Calibrator, 4-6, 4-31
dc coupling, 1-10, 1-14, 5-4, 5-6
DC level shifts, 3-16
default setup, 2-33
delay, 1-13
delay calibration, 4-32
Delay knobs, 2-3, 3-14
Delayed softkey, 2-3, 3-14
delayed sweep, 3-14, 3-17
 characteristics, 2-3 to 2-5, 3-14 to 3-15, 5-5
 operation, 2-3 to 2-5, 2-10, 3-14 to 3-15
delta t/delta V
 See cursor measurements
disassembly, 4-50
display
 characteristics, 5-8
 to adjust, 4-37 to 4-38
 to erase, 2-8
Display softkey, 4-37
distortion
 harmonic, 3-18 to 3-19
 worst case, 3-10
domain
 frequency, 3-18 to 3-19
 time, 3-18 to 3-19
Duty Cy softkey, 2-17
duty cycle, 2-16 to 2-17

E

EMI, 5-11
environmental characteristics, 5-11
Erase softkey, 2-7 to 2-8
erasing the display, 2-8
even field, 3-10 to 3-11
exploded view, 4-59
external trigger, 1-7, 1-15, 5-7, 5-14

Index

F

fall time, 2-16, 2-18
Fast Fourier Transform (FFT), 3-18 to 3-19
Field 1, 3-8
Field 1 softkey, 2-38
Field 2, 3-8
Field 2 softkey, 2-38
fields
 all, 3-9
 alternate, 3-5
 even, 3-10 to 3-11
 Field 1, 3-5, 3-10 to 3-11
 Field 2, 3-5, 3-10 to 3-11
 Field 3, 3-10 to 3-11
 Field 4, 3-10
 odd, 3-10 to 3-11
firmware calibration, 4-31
Freq softkey, 2-14
frequencies
 multi-burst, 3-14
frequency
 measurements, 2-14 to 2-15, 2-17
 reject, 2-28 to 2-29, 2-38, 5-6
frequency domain, 3-18 to 3-19
frequency domain analysis, 3-18
front-panel keys
 See keys listed by name

G

general characteristics, 5-11 to 5-12
GENERIC, 3-4 to 3-6
glitch capture, 2-10 to 2-11
graticule
 preset configuration, 2-33
 TV, 3-12, 3-14
grid
 softkeys, 3-2
 tv, 3-4

H

half bright contrast, 4-38
HF Rej softkey, 2-38
high frequency pulse response, 4-35
high frequency reject, 2-28, 2-38, 5-6
holdoff, 1-15, 2-12, 3-11
Holdoff knob, 1-15

horizontal
 accuracy, 5-5
 characteristics, 5-5
 hold, 4-38
 vernier, 1-12
humidity characteristics, 5-11

I

input
 capacitance, 5-3, 5-7
 coupling, 1-10, 1-14, 5-4, 5-7
 maximum voltage, 1-7, 5-3, 5-7
 resistance, 5-3, 5-7
inspecting, 1-6
instrument
 connect to, 3-20
interlaced TV system, 3-6
internal self tests, 4-46
internal trigger, 5-6, 5-14
interval
 vertical, 3-8
invert, 1-11, 5-4
IRE, 3-12

L

labels
 preset configuration, 2-33
level shifts
 DC, 3-16
LF reject, 2-29
line
 trigger, 1-14, 5-6, 5-14
 trigger (TV), 2-41, 5-6, 5-14
Line softkey
 Source, 1-14
 TV, 2-38
Load Defaults softkey, 4-31
low frequency
 compensation, 4-33
 reject, 2-29, 2-38, 5-6

M

main sweep, 2-3, 3-14
Main/Delayed key, 2-3, 3-14
marker, 3-14
 See cursor measurements
math functions, 5-3

maximum input voltage
 trigger, 5-7
 vertical, 5-3
measurement
 automatic, 2-16 to 2-21, 3-14
 clear, 2-17
 cursor, 3-12 to 3-13
 custom, 2-22, 3-12
 duty cycle, 2-16 to 2-17
 fall time, 2-16, 2-18
 frequency, 2-14 to 2-15, 2-17, 3-15
 period, 2-16 to 2-17
 phase, 2-34 to 2-36
 rise time, 2-16, 2-18
 show, 2-15, 2-17
 time, 2-16 to 2-18
 width, 2-16
 windowed, 3-16
measurements
 preset configuration, 2-33
memory
 preset configuration, 2-33
Mode key, 1-14
multi-burst, 3-15
multi-burst frequencies, 3-14

N

narrow pulses, 2-10 to 2-11
Next Menu softkey, 2-15, 2-17, 2-20
noise
 asynchronous signal, 2-26 to 2-27
 reject, 2-28
noisy signals
 to remove from display, 2-28 to 2-30
 to view, 2-26, 2-28 to 2-30
non-interlaced TV system, 3-6
nonvolatile memory, 2-31
Normal softkey, 1-15
NTSC, 3-4, 3-6, 3-10 to 3-11

-
- O**
- odd field, 3-10 to 3-11
 - offset
 - adjusting option 005, 4-39
 - one-channel acquisition, 2-9
 - Option 005, 3-2
 - characteristics, 5-13
 - offset adjustment, 4-39
 - replacing circuit board, 4-56
 - trigger system characteristics, 5-14
 - triggering, 3-5
 - troubleshooting, 4-48
 - verifying Vertical Output, 4-22
 - oscilloscope
 - configuration preset, 2-33
 - preset configuration, 2-33
 - oscilloscope maintenance, 4-5 to 4-21
 - output
 - vertical, 3-20
 - outputs
 - rear panel, 3-20
- P**
- PAL, PAL-M, 3-4, 3-6, 3-11
 - Peak Det softkey, 2-10
 - peak detect, 2-10
 - peak to peak voltage, 2-20
 - performance
 - test record, 4-22 to 4-25
 - tests, 4-5 to 4-21
 - verification, 4-5 to 4-21
 - performance characteristics
 - horizontal, 5-5
 - posttrigger, 5-5
 - pretrigger delay, 5-5
 - vertical, 5-2, 5-4
 - period measurements, 2-16 to 2-17
 - phase measurement, 2-34 to 2-36
 - physical characteristics, 5-12
 - Plot
 - See User's Guide for optional interface module
 - Position knob, 1-10
 - Power requirements, 5-10
 - power supply
 - to adjust, 4-28 to 4-29
 - voltage measurements, 4-29
 - preset configuration, 2-33
- Previous Menu softkey, 2-18
- Print
 - See User's Guide for optional interface module
- probe
 - attenuation factor, 1-7
 - compensation, 1-8
 - connection, 1-7
 - trimmer capacitor, 1-8
- Probe softkey, 1-7
- pulse
 - measurements, 2-16 to 2-18
 - sync, 3-7
- pulse parameters
 - See time measurements
- R**
- rear panel outputs, 3-20
 - rearming trigger, 2-8
 - Recall Setup softkey, 2-31
 - recall waveforms, 2-31
 - replaceable parts list, 4-63
 - replacement
 - list, 4-60, 4-63
 - parts, 4-57
 - reset setup, 2-33
 - reset the instrument, 2-33
 - rise time measurement, 2-16, 2-18
 - Rise Time softkey, 2-18
 - Roll
 - mode, 1-16
 - softkey, 1-16
 - Run, 2-7 to 2-8
- S**
- sample rate, 5-9
 - save
 - setups, 2-32
 - waveforms, 2-31
 - Save to softkey, 2-31
 - SECAM, 3-4, 3-6, 3-11
 - self-calibrations, 4-31 to 4-32
 - self-tests, 4-46
 - settings
 - default configuration, 2-33
 - setup
 - default, 2-33
 - reset, 2-33
 - setup saving, 2-32
 - Show Meas softkey, 2-15, 2-17
 - signal
 - automatic display, 1-9
 - dc component, 1-10
 - noise, 2-26, 2-30
 - single
 - event, 2-8 to 2-9
 - trigger, 2-8 to 2-9
 - single shot
 - bandwidth, 2-9
 - event, 2-9
 - Single softkey, 2-8
 - Slope/Coupling key, 2-8
 - softkey, 1-3
 - See keys listed by name
 - Source softkey, 1-14, 2-14, 2-17, 2-20
 - specifications
 - See characteristics
 - status line, 1-2 to 1-3, 3-2, 3-14
 - Stop key, 2-7, 2-9
 - storage operation, 2-6 to 2-7
 - sub bright, 4-37
 - subtract waveforms, 5-3
 - sweep
 - delayed, 1-12 to 1-13, 3-14, 3-17, 5-5
 - main, 1-12 to 1-13, 3-14, 5-5
 - roll, 1-16
 - speed, 1-12 to 1-13, 5-5
 - sync
 - amplitude, 3-5
 - burst color, 3-7
 - pulse vertical, 3-6
 - pulses, 3-7
 - sync pulse, 3-15
- T**
- temperature
 - characteristics, 5-11
 - warm up, 4-5, 4-27
 - test
 - vertical interval signal, 3-5
 - test record, 4-22 to 4-25
 - threshold
 - preset configuration, 2-33
-

Index

-
- time base
 - accuracy, 5-5
 - preset configuration, 2-33
 - range, 1-12, 5-5
 - setup, 1-12 to 1-13
 - time cursor, 3-12
 - time domain, 3-18 to 3-19
 - Time key, 2-14
 - time measurements
 - duty cycle, 2-16 to 2-18
 - fall time, 2-16 to 2-18
 - frequency, 2-16 to 2-18
 - period, 2-16 to 2-18
 - rise time, 2-16 to 2-18
 - width, 2-16 to 2-18
 - time reference, 2-4
 - Time/Div, 2-3, 3-14
 - trace
 - memory, 2-31
 - recall, 2-31
 - softkey, 2-31
 - to save, 2-31
 - Trace Mem softkey, 2-31
 - trigger
 - characteristics, 5-6, 5-14
 - complex waveforms, 2-12
 - external, 1-7, 1-15, 5-7, 5-14
 - holdoff, 1-15, 2-12
 - internal, 5-6, 5-14
 - level, 1-14, 2-8
 - loss of, 1-15
 - mode, 1-14 to 1-15
 - point, 1-13
 - posttrigger information, 1-13
 - preset configuration, 2-33
 - pretrigger information, 1-13
 - rearming, 2-8
 - roll, 1-16
 - single, 2-8 to 2-9
 - slope, 2-8
 - source, 1-14 to 1-15, 2-8, 3-20
 - to verify, 4-18
 - TV, 1-15, 2-38, 2-41, 3-16
 - TV mode, 2-38
 - troubleshooting the oscilloscope, 4-9
 - TV
 - display grid, 3-4
 - grid, 3-12
 - trigger, 1-14, 2-38, 2-41, 3-16
 - trigger mode, 2-38
 - trigger-both fields, 2-41
 - vertical sync, 2-41
 - TV graticule, 3-12, 3-14
 - TV softkeys, 1-14
 - two-channel acquisition, 2-9
 - U**
 - undo autoscale, 2-33, 3-4
 - V**
 - vernier
 - accuracy, 5-4 to 5-5
 - horizontal, 1-12, 5-5
 - vertical, 1-11
 - Vernier softkey, 1-11 to 1-12
 - Vert Rej, 3-7
 - vertical
 - calibration, 4-32
 - characteristics, 5-3 to 5-4
 - interval, 3-7 to 3-8
 - interval reject, 3-7
 - interval test signal (VITS), 3-5, 3-16 to 3-17
 - linearity, 4-38
 - reject, 3-7
 - scaling, 1-7, 1-11
 - sensitivity, 1-11
 - size, 4-38
 - step size, 1-11
 - sync, 2-41
 - sync interval, 3-8
 - window, 1-10 to 1-11
 - vertical output, 3-20
 - Vertical softkey, 4-32
 - Vertical Sync, 3-10
 - video
 - autoscale, 3-4, 3-16
 - signal, 3-4
 - signal components, 3-8
 - signal envelope, 3-10
 - signal unclamped, 3-16
 - trigger, 2-38, 2-41, 3-16
 - waveforms, 2-38 to 2-41, 3-16 to 3-17
 - video autoscale, 3-12
 - VITS, 2-38
 - voltage
 - adjustment, 4-28
 - maximum input, 1-7, 5-3
 - measurement accuracy, 4-7
 - measurements, 2-19 to 2-21
 - peak to peak, 2-20
 - Vavg, 2-20
 - Vbase, 2-21
 - vernier, 1-11
 - Vmax, 2-21
 - Vmin, 2-21
 - Vrms, 2-20
 - Vtop, 2-21
 - voltage cursor, 3-12
 - volts versus time, 2-34
 - volts versus volts, 2-34
 - Volts/Div knob, 1-11
 - W**
 - waveform
 - complex, 2-12
 - saving, 2-31
 - width, 2-16, 2-18
 - V**
 - verifying Vertical Output
 - X**
 - XY
 - characteristics, 5-8
 - cursors, 2-34 to 2-37
 - display mode, 2-34 to 2-37
 - measurements, 2-36
 - XY softkey, 2-34
 - Z**
 - Z-blanking, 2-35
-

DECLARATION OF CONFORMITY

according to ISO/IEC Guide 22 and EN 45014

Manufacturer's Name: Hewlett-Packard Company

Manufacturer's Address: Colorado Springs Division
1900 Garden of the Gods Road
Colorado Springs, CO 80907 USA

declares, that the product

Product Name: Digitizing Oscilloscope

Model Number(s): HP 54600B, HP 54601B, HP 54602B, and HP 54603B

Product Option(s): All

conforms to the following Product Specifications:

Safety: IEC 1010-1:1990+A1 / EN 61010-1:1993
UL 3111
CSA-C22.2 No. 1010.1:1993

EMC: CISPR 11:1990 / EN 55011:1991 Group 1 Class A
IEC 555-2:1982 + A1:1985 / EN 60555-2:1987
IEC 555-3:1982 + A1:1990 / EN 60555-3:1987 + A1:1991
IEC 801-2:1991 / EN 50082-1:1992 4 kV CD, 8 kV AD
IEC 801-3:1984 / EN 50082-1:1992 3 V/m, {1kHz 80% AM, 27-1000 MHz}
IEC 801-4:1988 / EN 50082-1:1992 0.5 kV Sig. Lines, 1 kV Power Lines

Supplementary Information:

The product herewith complies with the requirements of the Low Voltage Directive 73/23/EEC and the EMC Directive 89/336/EEC and carries the CE marking accordingly.

This product was tested in a typical configuration with Hewlett-Packard test systems.

Colorado Springs, 01/23/97

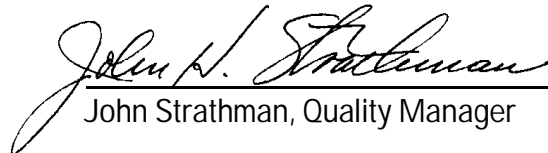
John Strathman, Quality Manager

European Contact: Your local Hewlett-Packard Sales and Service Office or Hewlett-Packard GmbH, Department ZQ / Standards Europe, Herrenberger Strasse 130, D-71034 Böblingen Germany (FAX: +49-7031-14-3143)

Product Regulations

Safety IEC 1010-1:1990+A1 / EN 61010-1:1993
UL 3111
CSA-C22.2 No.1010.1:1993

EMC This Product meets the requirement of the European Communities (EC)
EMC Directive 89/336/EEC.



Emissions EN55011/CISPR 11 (ISM, Group 1, Class A equipment)

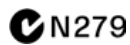

Immunity	EN50082-1	Code ¹	Notes ²
	IEC 555-2	1	
	IEC 555-3	1	
	IEC 801-2 (ESD) 4kV CD, 8kV AD	2	
	IEC 801-3 (Rad.) 3 V/m	2	
	IEC 801-4 (EFT) 0.5 kV, 1kV	1	

¹ Performance Codes:

- 1 PASS - Normal operation, no effect.
- 2 PASS - Temporary degradation, self recoverable.
- 3 PASS - Temporary degradation, operator intervention required.
- 4 FAIL - Not recoverable, component damage.

² Notes: (none)

Sound Pressure Level Less than 60 dBA

© Copyright Hewlett-Packard Company, 1992, 1997
All Rights Reserved.

Reproduction, adaptation, or translation without prior written permission is prohibited, except as allowed under the copyright laws.

Restricted Rights Legend.

Use, duplication or disclosure by the U.S. Government is subject to restrictions as set forth in subparagraph (c) (1) (ii) of the Rights in Technical Data and Computer Software clause at DFARS 252.227-7013 for DOD agencies, and subparagraphs (c) (1) and (c) (2) of the Commercial Computer Software Restricted Rights clause at FAR 52.227-19 for other agencies.

Hewlett-Packard Company
3000 Hanover Street
Palo Alto, California 94304
U.S.A.

Document Warranty

The information contained in this document is subject to change without notice.

Hewlett-Packard makes no warranty of any kind with regard to this material, including, but not limited to, the implied warranties of merchantability or fitness for a particular purpose.

Hewlett-Packard shall not be liable for errors contained herein or for damages in connection with the furnishing, performance, or use of this material.

Safety

This apparatus has been designed and tested in accordance with IEC Publication 1010, Safety Requirements for Measuring Apparatus, and has been supplied in a safe condition. This is a Safety Class I instrument (provided with terminal for protective earthing). Before applying power, verify that the correct safety precautions are taken (see the following warnings). In addition, note the external markings on the instrument that are described under "Safety Symbols."

Warning

- Before turning on the instrument, you must connect the protective earth terminal of the instrument to the protective conductor of the (mains) power cord. The mains plug shall only be inserted in a socket outlet provided with a protective earth contact. You must not negate the protective action by using an extension cord (power cable) without a protective conductor (grounding). Grounding one conductor of a two-conductor outlet is not sufficient protection.
- Only fuses with the required rated current, voltage, and specified type (normal blow, time delay, etc.) should be used. Do not use repaired fuses or short-circuited fuseholders. To do so could cause a shock or fire hazard.
- Service instructions are for trained service personnel. To avoid dangerous electric shock, do not perform any service unless qualified to do so. Do not attempt internal service or adjustment unless another person, capable of rendering first aid and resuscitation, is present.
- If you energize this instrument by an auto transformer (for voltage reduction), make sure the common terminal is connected to the earth terminal of the power source.
- Whenever it is likely that the ground protection is impaired, you must make the instrument inoperative and secure it against any unintended operation.
- Do not operate the instrument in the presence of flammable gasses or fumes. Operation of any electrical instrument in such an environment constitutes a definite safety hazard.
- Do not install substitute parts or perform any unauthorized modification to the instrument.
- Capacitors inside the instrument may retain a charge even if the instrument is disconnected from its source of supply.
- Use caution when exposing or handling the CRT. Handling or replacing the CRT shall be done only by qualified maintenance personnel.

Safety Symbols



Instruction manual symbol: the product is marked with this symbol when it is necessary for you to refer to the instruction manual in order to protect against damage to the product.



Hazardous voltage symbol.



Earth terminal symbol: Used to indicate a circuit common connected to grounded chassis.

WARNING

The Warning sign denotes a hazard. It calls attention to a procedure, practice, or the like, which, if not correctly performed or adhered to, could result in personal injury. Do not proceed beyond a Warning sign until the indicated conditions are fully understood and met.

CAUTION

The Caution sign denotes a hazard. It calls attention to an operating procedure, practice, or the like, which, if not correctly performed or adhered to, could result in damage to or destruction of part or all of the product. Do not proceed beyond a Caution symbol until the indicated conditions are fully understood or met.

Hewlett-Packard
P.O. Box 2197
1900 Garden of the Gods Road
Colorado Springs, CO 80901

Product Warranty

This Hewlett-Packard product has a warranty against defects in material and workmanship for a period of three years from date of shipment. During the warranty period,

Hewlett-Packard Company will, at its option, either repair or replace products that prove to be defective.

For warranty service or repair, this product must be returned to a service facility designated by Hewlett-Packard.

For products returned to Hewlett-Packard for warranty service, the Buyer shall prepay shipping charges to Hewlett-Packard and Hewlett-Packard shall pay shipping charges to return the product to the Buyer. However, the Buyer shall pay all shipping charges, duties, and taxes for products returned to Hewlett-Packard from another country.

Hewlett-Packard warrants that its software and firmware designated by Hewlett-Packard for use with an instrument will execute its programming instructions when properly installed on that instrument.

Hewlett-Packard does not warrant that the operation of the instrument software, or firmware will be uninterrupted or error free.

Limitation of Warranty

The foregoing warranty shall not apply to defects resulting from improper or inadequate maintenance by the Buyer, Buyer-supplied software or interfacing, unauthorized modification or misuse, operation outside of the environmental specifications for the product, or improper site preparation or maintenance.

No other warranty is expressed or implied. Hewlett-Packard specifically disclaims the implied warranties of merchantability or fitness for a particular purpose.

Exclusive Remedies

The remedies provided herein are the buyer's sole and exclusive remedies. Hewlett-Packard shall not be liable for any direct, indirect, special, incidental, or consequential damages, whether based on contract, tort, or any other legal theory.

Assistance

Product maintenance agreements and other customer assistance agreements are available for Hewlett-Packard products.

For any assistance, contact your nearest Hewlett-Packard Sales Office.

Certification

Hewlett-Packard Company certifies that this product met its published specifications at the time of shipment from the factory. Hewlett-Packard further certifies that its calibration measurements are traceable to the United States National Institute of Standards and Technology, to the extent allowed by the Institute's calibration facility, and to the calibration facilities of other International Standards Organization members.

About this edition

This is the *HP 54600B, HP54601B, HP 54602B, and HP 54603B Oscilloscopes User and Service Guide*.

Publication number
54600-97021, November 1997
Printed in USA.

Print history is as follows:
54600-97021, November 1997
54600-97019, May 1997
54600-97004, June 1992

New editions are complete revisions of the manual. Many product updates do not require manual changes; and, conversely, manual corrections may be done without accompanying product changes. Therefore, do not expect a one-to-one correspondence between product updates and manual updates.